

DOCUMENT RESUME

ED 100 003

EA 006 622

**TITLE** Solar Heating Proof-of-Concept Experiment for a Public School Building. Report for the Period 15 Jan. 1974 to 15 May 1974. No. ER-7934.

**INSTITUTION** AAI Corp., Baltimore, Md.  
**SPONS AGENCY** National Science Foundation, Washington, D.C. RANN Program.

**REPORT NO** ER-7934; NSF-RA-N-74-096

**PUB DATE** Jun 74

**NOTE** 126p.; Related documents are EA 006 623-626;

Photographs will reproduce poorly  
**AVAILABLE FROM** Superintendent of Documents, U.S. Government Printing Office, Washington, D.C. 20402 (Stock No. 3800-00191, \$3.05)

**EDRS PRICE** MF-\$0.75 HC-\$6.60 PLUS POSTAGE

**DESCRIPTORS** Blueprints; Building Materials; Capital Outlay (for Fixed Assets); Cost Effectiveness; Electrical Systems; Elementary Education; \*Energy Conservation; Equipment Maintenance; \*Experiments; Fuel Consumption; \*Heating; Operating Expenses; Performance Criteria; \*Solar Radiation; Technological Advancement; \*Thermal Environment

**ABSTRACT**

In the middle of January 1974, AAI Corporation received a contract to conduct a solar heating proof-of-concept experiment (POCE) for a public school building. On March 1, 1974, the experiment began as Timonium Elementary School, in Maryland, became the first school in the United States to be heated by solar energy. In this brief period, the corporation designed, manufactured, and installed a solar energy collector array complete with mounting trusses, a 15,000 gallon water storage tank, a hot water heating system, and instrumentation. From March 1 to May 15 the wing of the school chosen for the solar experiment received 90 percent of its heat from the solar heating system. Experimental data collected during this period is presented in this report. The report describes the system in detail, presents the analysis of operation, and discusses recommendations and conclusions based on the results of the experiment. The experiment is considered successful since it has proven that the solar heating of schools is possible, practical, and socially acceptable. In addition, over 1,200 gallons of fuel oil were saved in the brief period the system has been in operation.

(Author/NLF)

BEST COPY AVAILABLE

# Solar Heating

BEST COPY AVAILABLE

# Proof-of-Concept Experiment for a Public School Building

**AAI Corporation**

**P.O. Box 6767**

**Baltimore, Maryland 21204**

**(301) 666-1400**

**June 1974**

U S DEPARTMENT OF HEALTH,  
EDUCATION & WELFARE  
NATIONAL INSTITUTE OF  
EDUCATION

THIS DOCUMENT HAS BEEN REPRO-  
DUCED EXACTLY AS RECEIVED FROM  
THE PERSON OR ORGANIZATION ORIGIN-  
ATING IT. POINTS OF VIEW OR OPINIONS  
STATED DO NOT NECESSARILY REPRE-  
SENT OFFICIAL NATIONAL INSTITUTE OF  
EDUCATION POSITION OR POLICY

**Report for the Period  
15 Jan. 1974 to 15 May 1974**

**ER-7934**

Any opinions, findings, conclusions or recommendations expressed  
in this publication are those of the author(s) and do not necessarily  
reflect the views of the National Science Foundation.

BEST COPY AVAILABLE

Prepared for

**National Science Foundation**

**RANN/Research Applied to National Needs**

**Washington, D.C. 20550**

For sale by the Superintendent of Documents, U.S. Government Printing Office  
Washington, D.C. 20402 - Price \$3.05  
Stock Number 3800-00191

ED100003

EA 006 622

# TABLE OF CONTENTS

| <u>Section</u> |   | <u>Page</u> |
|----------------|---|-------------|
|                | <b>EXECUTIVE SUMMARY</b>  | <b>1</b>    |
| <b>I</b>       | <b>INTRODUCTION - - - - -</b>                                   | <b>19</b>   |
| <b>II</b>      | <b>GENERAL DESCRIPTION OF SYSTEM - - - - -</b>                  | <b>20</b>   |
|                | <b>A. Timonium Elementary School - - - - -</b>                  | <b>20</b>   |
|                | <b>B. Solar Collectors - - - - -</b>                            | <b>25</b>   |
|                | <b>C. Supporting Structure - - - - -</b>                        | <b>34</b>   |
|                | <b>D. Collector Plumbing - - - - -</b>                          | <b>39</b>   |
|                | <b>E. School Convectors (Unit Heaters) - - - - -</b>            | <b>43</b>   |
|                | <b>F. Storage Tank - - - - -</b>                                | <b>49</b>   |
|                | <b>G. Instrumentation - - - - -</b>                             | <b>56</b>   |
| <b>III</b>     | <b>ANALYSIS OF OPERATION - - - - -</b>                          | <b>63</b>   |
|                | <b>A. Direct Operating Costs of Solar Heating System - - -</b>  | <b>63</b>   |
|                | <b>B. Fuel Savings - - - - -</b>                                | <b>68</b>   |
|                | <b>C. Maintenance Required - - - - -</b>                        | <b>70</b>   |
|                | <b>D. Capital Equipment Costs - - - - -</b>                     | <b>72</b>   |
|                | <b>E. Solar Collecting Performance and Efficiency - - - - -</b> | <b>79</b>   |
|                | <b>F. Typical Days Operation (22 March 1974) - - - - -</b>      | <b>84</b>   |
|                | <b>G. Heat Input and Output Summary - - - - -</b>               | <b>86</b>   |

TABLE OF CONTENTS (cont'd.)

| <u>Section</u> |   | <u>Page</u> |
|----------------|---|-------------|
| IV             | RECOMMENDATIONS AND CONCLUSIONS - - - - - | 90          |

APPENDICES:

|    |  |     |
|----|--|-----|
| A. | Drawings - - - - -   | 93  |
|    | 57413-40024 Plumbing Schematic                               | 95  |
|    | 57413-40032 Sh. 1 & Sh. 2 Water Storage Tank                 | 96  |
|    | 57413-40042 Installation Solar Panel Trusses                 | 98  |
|    | 57413-40069 Sh. 1 & Sh. 2 Instrumentation Layout & Schematic | 99  |
|    | 57413-40114 Piping Schematic                                 | 101 |
|    | 57413-40120 Solar Plumbing System                            | 102 |
| B. | Chart of Data for a Typical Day of Operation - - - - -       | 103 |
| C. | Water Analysis Reports - - - - -                             | 107 |

## LIST OF FIGURES

| <u>Figure</u> | <u>Title</u>  | <u>Page</u> |
|---------------|---|-------------|
| 2-1           | Artist's Concept of Timonium Elementary School - - - - -  | 21          |
| 2-2           | Center Wing of Timonium Elementary School Before<br>Installation of the Solar Heating Experiment- - - - - | 22          |
| 2-3           | Center Wing of Timonium Elementary School After<br>Installation of the Solar Heating Experiment- - - - -  | 23          |
| 2-4           | Solar Energy Experiment - Timonium Elementary School - -  | 24          |
| 2-5           | Sawing Water Slots in the Unexpanded Honeycomb - - - - -  | 26          |
| 2-6           | Installing Neoprene Rubber Edging Strip<br>on the Collectors - - - - -                                    | 27          |
| 2-7           | Fabricated Solar Collectors - - - - -   | 28          |
| 2-8           | Solar Collectors in Manufacturing Area - - - - -  | 29          |
| 2-9           | Lifting the Collectors to the School Roof<br>Using a Pallet and Crane - - - - -                           | 30          |
| 2-10          | Collectors Mounted on Roof<br>Before Installation of Plumbing - - - - -                                   | 32          |
| 2-11          | Collector Hose Being Installed into Drain Line - - - - -  | 33          |
| 2-12          | Roof of School Before Solar Heating Installation - - - - -  | 35          |
| 2-13          | Trusses Stored at AAI Before Shipment to School - - - - -   | 36          |
| 2-14          | Truss Being Lifted to Roof - - - - -  | 37          |
| 2-15          | Installed Trusses with Collectors - - - - -   | 38          |
| 2-16          | External View of Pump House - - - - -   | 41          |

**LIST OF FIGURES (cont'd.)**

| <u>Figure</u> | <u>Title</u>  | <u>Page</u> |
|---------------|---|-------------|
| 2-17          | Internal View of Pump House - - - - -   | 42          |
| 2-18          | Steam Boilers Used for Heating<br>Timonium Elementary School - - - - -                      | 44          |
| 2-19          | Heating and Ventilating Steam Unit<br>with Protective Cover Removed - - - - -               | 45          |
| 2-20          | View of Typical Ventilation Opening for the<br>Heating and Ventilating Steam Unit - - - - - | 46          |
| 2-21          | Two of the Solar Hot Water- Forced Air Convectors - - - - -                                 | 47          |
| 2-22          | Solar Hot Water- Forced Air Convectors Mounted<br>in the Ceiling of the Library - - - - -   | 48          |
| 2-23          | Storage Tank in the Weld Shop<br>Trusses are Shown on the Left - - - - -                    | 50          |
| 2-24          | Storage Tank Loaded on Truck for Delivery to Site - - - - -                                 | 51          |
| 2-25          | Storage Tank Being Lowered Onto Its Pad by Crane- - - - -                                   | 52          |
| 2-26          | Insulation Being Applied to the Solar Collector<br>Pipes and the Storage Tanks - - - - -    | 54          |
| 2-27          | Fully Insulated Tank - - - - -  | 55          |
| 2-28          | Overall View of the Instrumentation and Control Panels - -                                  | 57          |
| 2-29          | Control Panel with Schematics - - - - -   | 58          |
| 2-30          | Close-Up View of Solar Heating Control Panel- - - - -                                       | 59          |
| 3-1           | Cost of Electrical Energy Used in<br>Collection of Solar Heat - - - - -                     | 64          |
| 3-2           | KW-Hr of Electricity Required for<br>Instrumentation Operation - - - - -                    | 65          |

**LIST OF FIGURES (cont'd.)**

| <u>Figure</u> | <u>Title</u>  | <u>Page</u> |
|---------------|---|-------------|
| 3-3           | Supply and Distribution Cost of Solar Energy for School Heating - - - - -   | 66          |
| 3-4           | Total System Operating Cost - - - - -   | 67          |
| 3-5           | Estimated Fuel Savings in Timonium School Utilizing Solar Heat for Center Wing Area of School- - - - -              | 69          |
| 3-6           | Operational Maintenance Performed on Timonium Solar Heating System - - - - -  | 71          |
| 3-7           | Actual Capital Equipment Costs of AAI Solar Energy Proof-of-Concept Experiment (Expedited Program)- - - - -         | 73          |
| 3-8           | Estimated Capital Equipment Costs of AAI Solar Energy Proof-of-Concept Experiment (Non-expedited Program) - - - - - | 74          |
| 3-9           | School Capital Cost Comparisons and Projections- - - - -  | 78          |
| 3-10          | Semi-Monthly Trend of Solar Collection Performance - - - - -  | 80          |
| 3-11          | Monthly and Total Summary of Solar Heat Collection Performance - - - - -  | 81          |
| 3-12          | Typical Day's Operation of the Timonium Solar Heating System - - - - -  | 85          |
| 3-13          | Operational Performance of the Timonium Solar Heating System for the Period of March 1974 to 15 May 1974 - - - - -  | 87          |
| 3-14          | Average Number of BTU's Collected, Available, and Expended per Day - - - - -  | 88          |
| 3-15          | Total System Heat Input and Output During the Operational Period of the System - - - - -                            | 89          |

## EXECUTIVE SUMMARY

### I. INTRODUCTION

On January 14, 1974, AAI Corporation received Contract Number NSF-871 from the National Science Foundation to conduct a Solar Heating Proof-of-Concept Experiment (POCE) for a public school building. On March 1, 1974, one and a half months later, the experiment began as Timonium Elementary School became the first school in the United States heated by solar energy. In this brief period of time, AAI designed, manufactured, and installed a 5000 ft<sup>2</sup> collector array complete with mounting trusses, a 15,000 gallon water storage tank, school hot water heating system, and instrumentation.

From March 1 to May 15 the selected wing of the school received 90% of its heat from the solar heating system. During this period, experimental data was collected and is presented in this report.

This experiment has been successful since it has proven that the solar heating of schools is possible, practical, and socially acceptable. In addition, over 1200 gallons of fuel oil have been saved in the brief period the system has been in operation.

This report describes the system in detail, presents the analysis of operation, and discusses recommendations and conclusions based upon the results of the experiment so far.



## II. DESCRIPTION OF SYSTEM

The charts, figures, and photographs on Figures ES-1 through ES-15 graphically show the Solar Heating System built and installed on Timonium Elementary School by AAI. A detailed description of each element of the system is contained in the main body of the report.

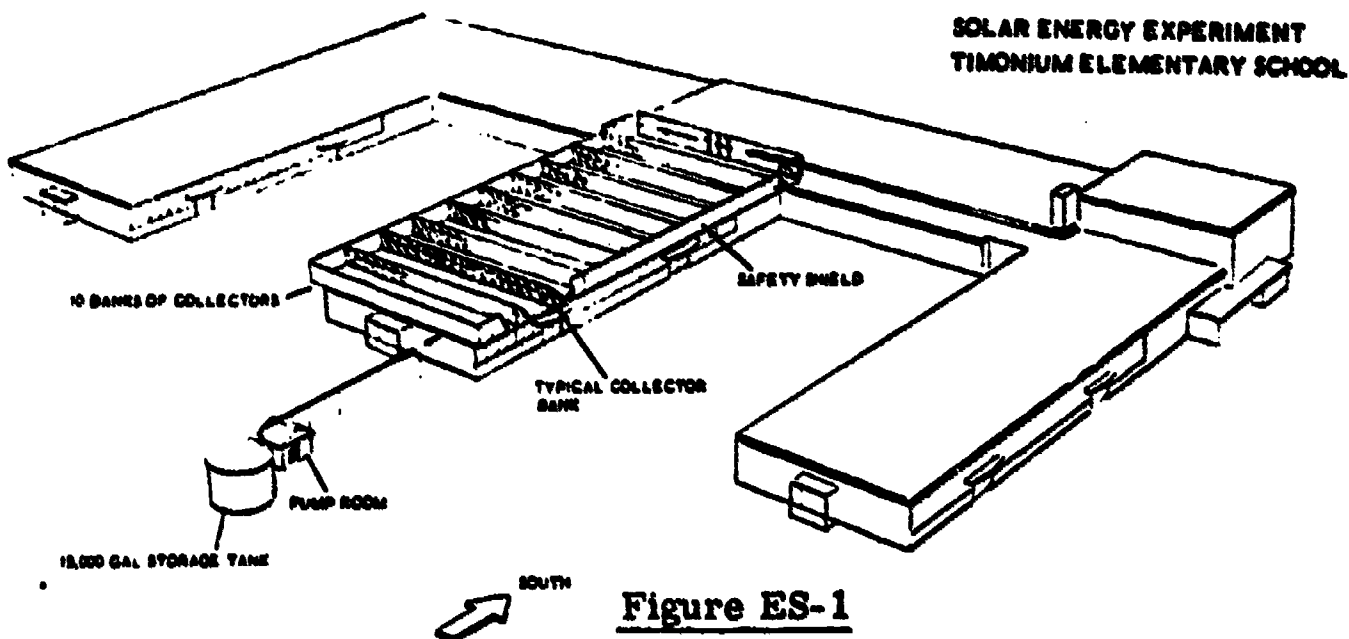
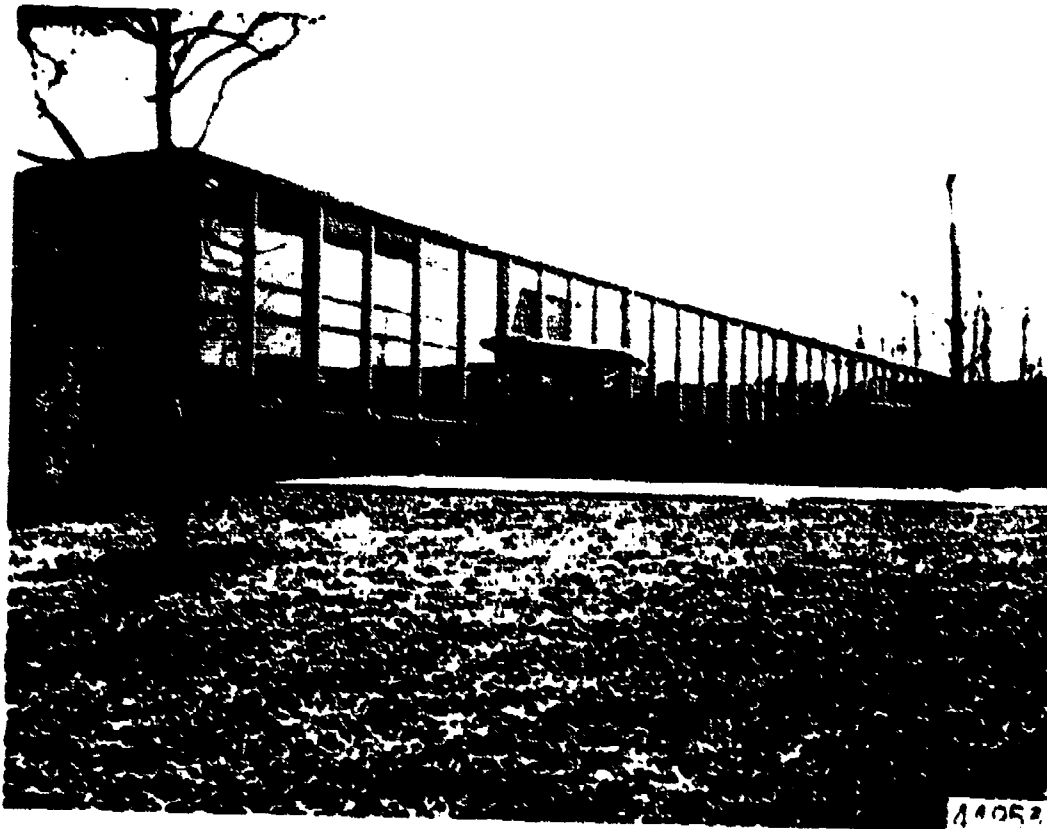

**Figure ES-1**

### Data Sheet Timonium Elementary School Solar Heating Pilot Project

|  |                   |
|--|-------------------|
| Area Center Wing (67 x 143) - - - - -                                | 9581 sq. ft.      |
| Solar Panel Area - - - - -   | 28 sq. ft.        |
| Area of Solar Collector (180 panels) - - - - -                       | 5040 sq. ft.      |
| Ratio of Collector Area to Floor Area - - - - -                      | .527              |
| Storage - Hot Water Volume - - - - -                                 | 15,000 gal.       |
| Ratio of Storage Volume to Collector Area - - - - -                  | 2.98 gal./sq. ft. |
| Availability of Solar Heating (@40% eff.) to Heating Requirement - % |                   |
| October      300%  | January      52%  |
| November    105%   | February     94%  |
| December    50%  | March        160% |

**Figure ES-2**



Wing of School Before Installation of Solar Collectors

Figure ES-3



Wing of School After Solar Heating Installation Showing Screen

Figure ES-4

BEST COPY AVAILABLE

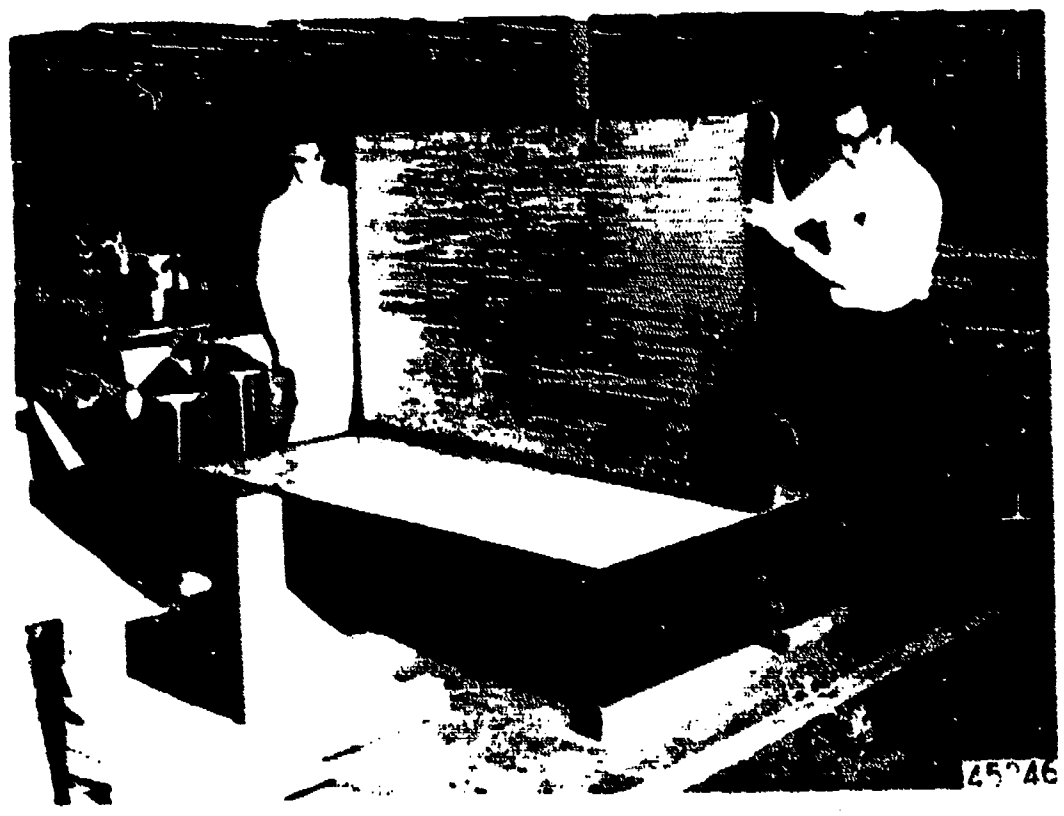

Solar Collectors in AAI Manufacturing Area

Figure ES-5

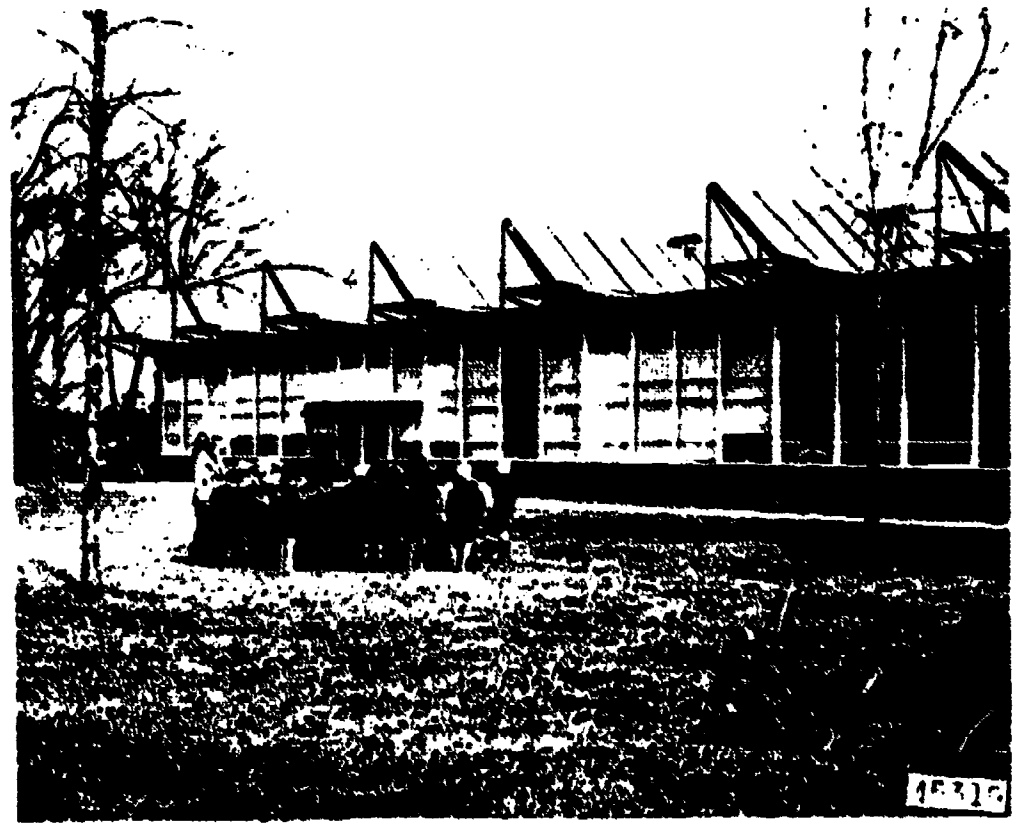

Students Viewing Construction

Figure ES-6

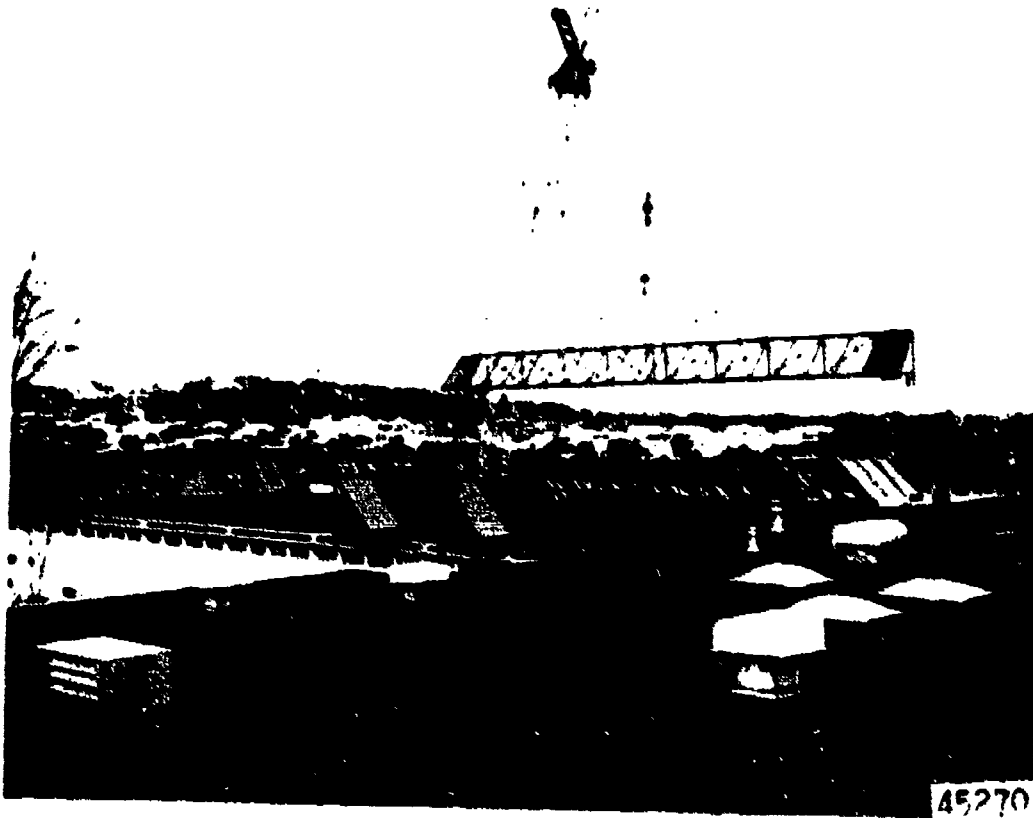

**Installation of Trusses**

**Figure ES-7**



**Solar Array of 180 Collectors**

**Figure ES-8**

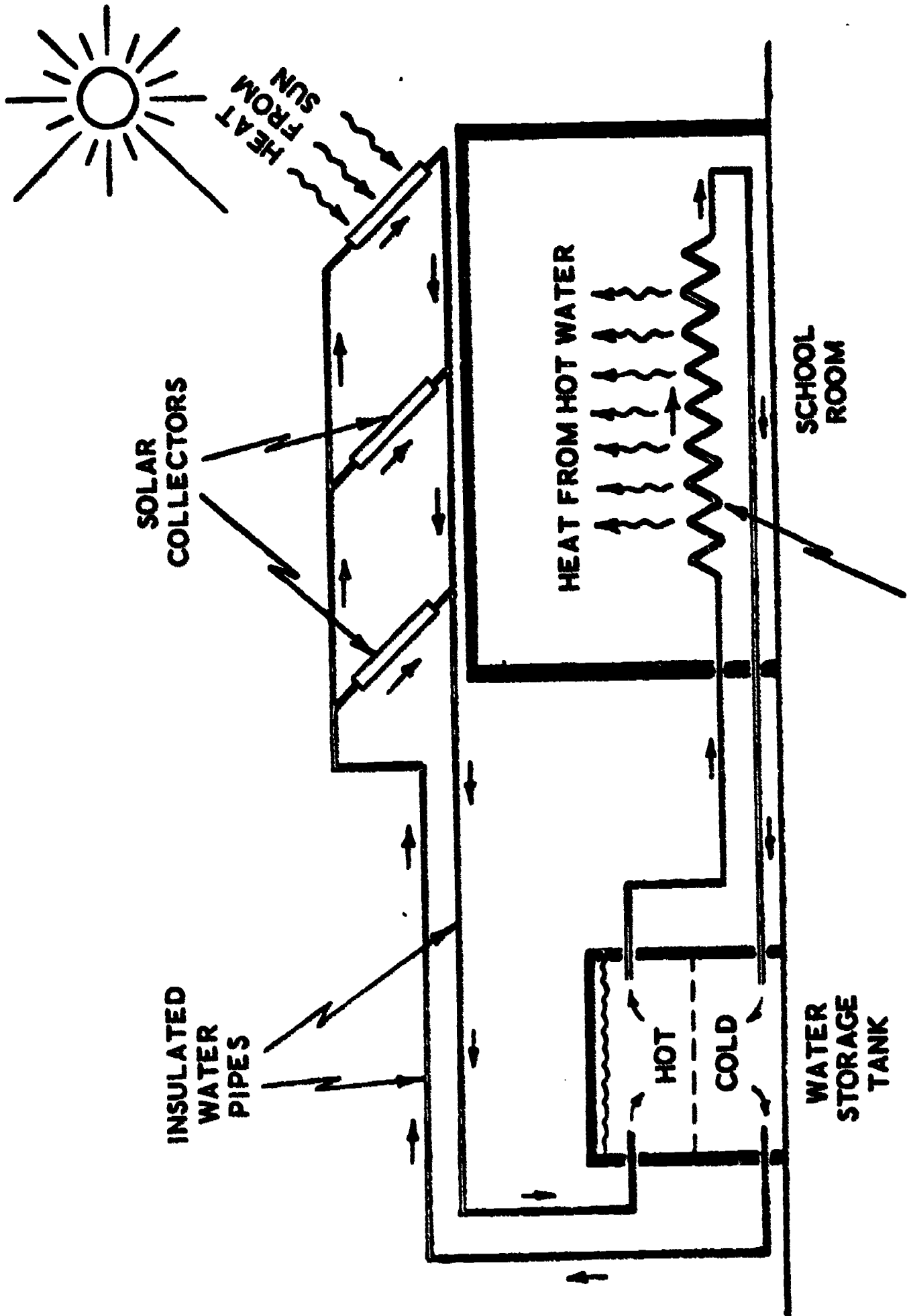

**HEAT FROM HOT WATER**  
**HEAT FROM SUN**  
**SOLAR COLLECTORS**  
**INSULATED WATER PIPES**  
**WATER STORAGE TANK**  
**HOT COLD**  
**HOT WATER CONVECTOR**  
**SCHOOL ROOM**  
 Graphic Illustration of Solar System

Figure ES-9

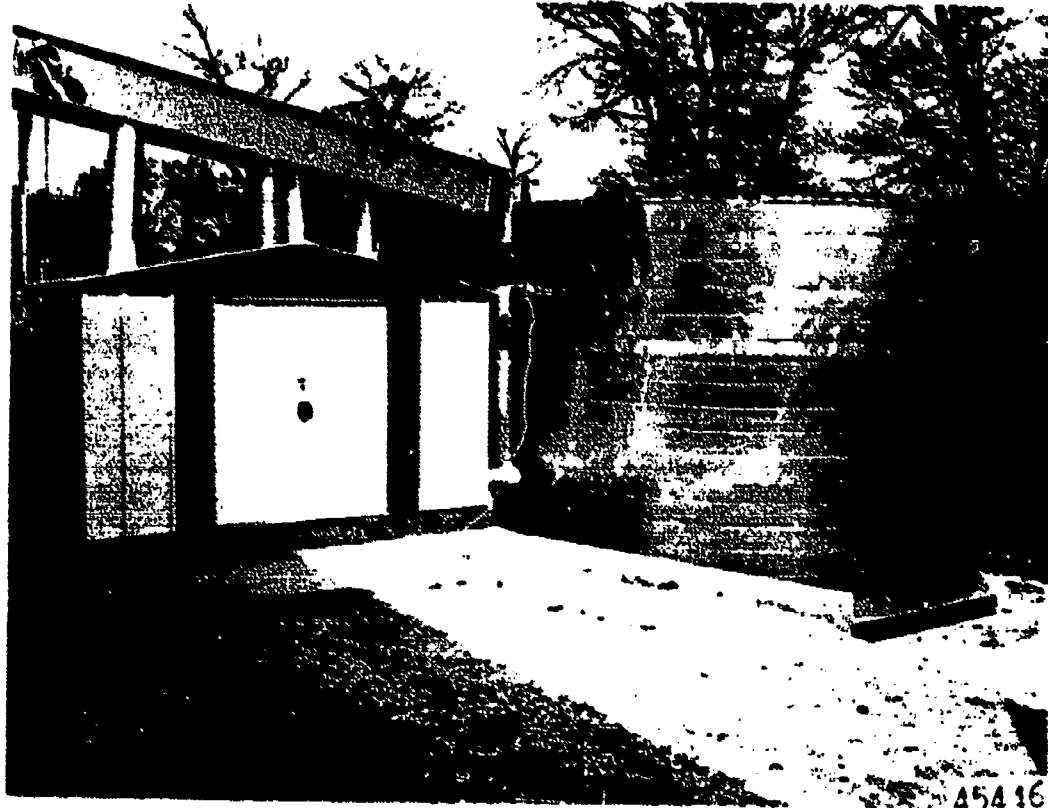

**Pump House and 15,000 Gal. Capacity Insulated Water Storage Tank  
Figure ES-10**

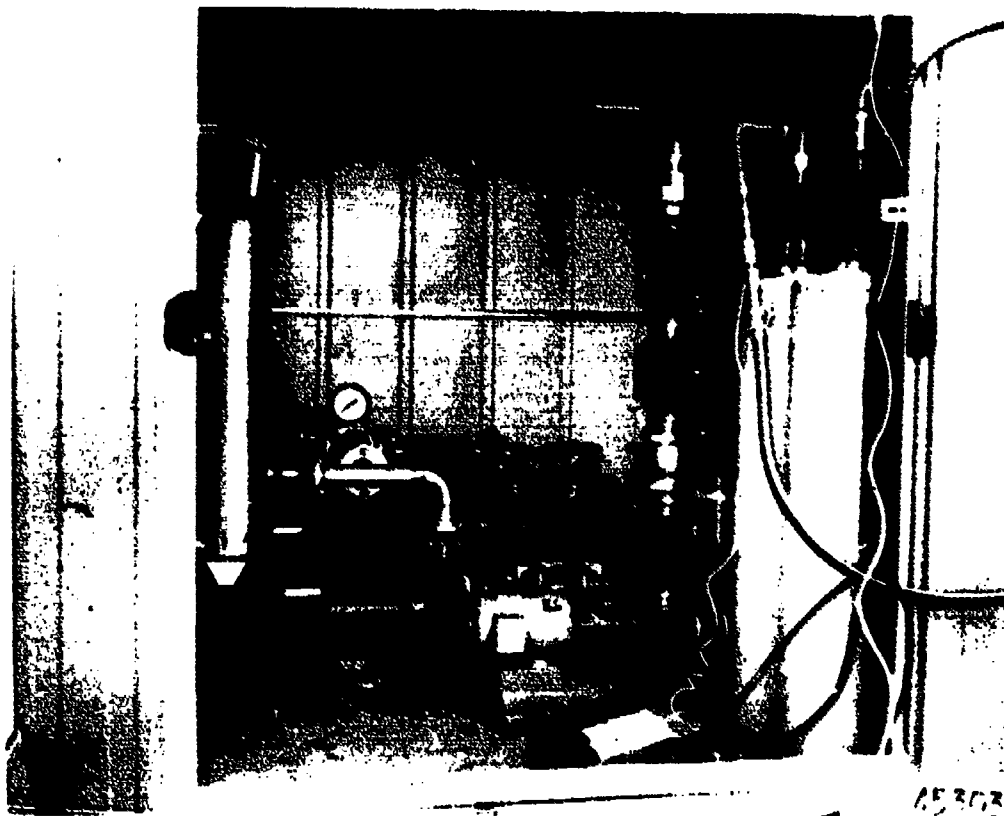

**Inside Pump House During Construction Stage  
Showing Pumps, Filters, and Water Deionization Tanks**

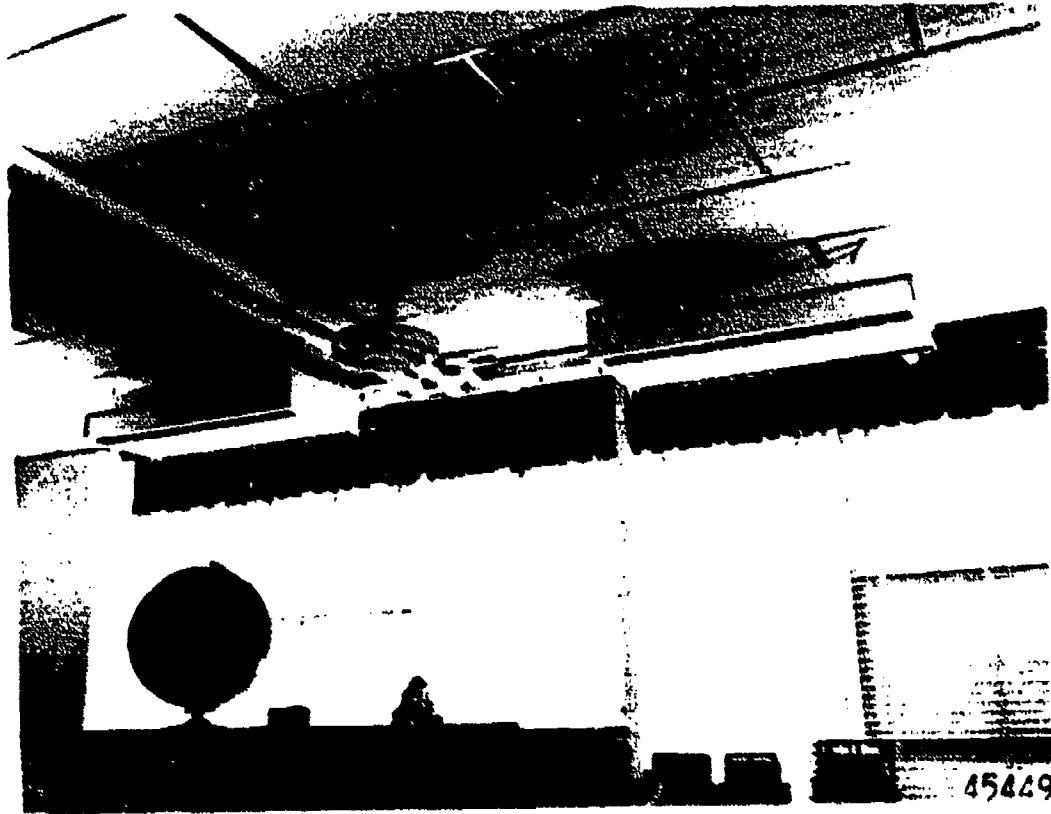

**Ceiling Mounted Hot Water Convectors Added To  
Library to Provide Solar Heat**

**Figure ES-12**

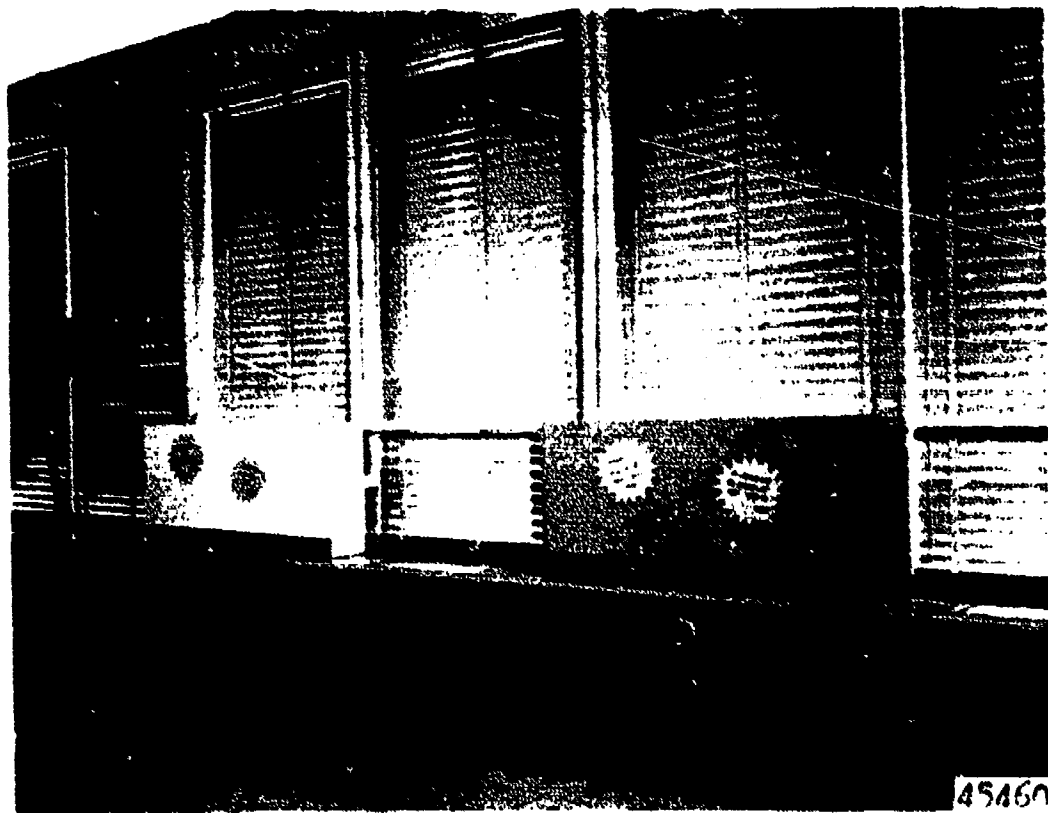

**Two Hot Water Convectors Added to Typical  
Classroom to Provide Solar Heat**

**Figure ES-13**

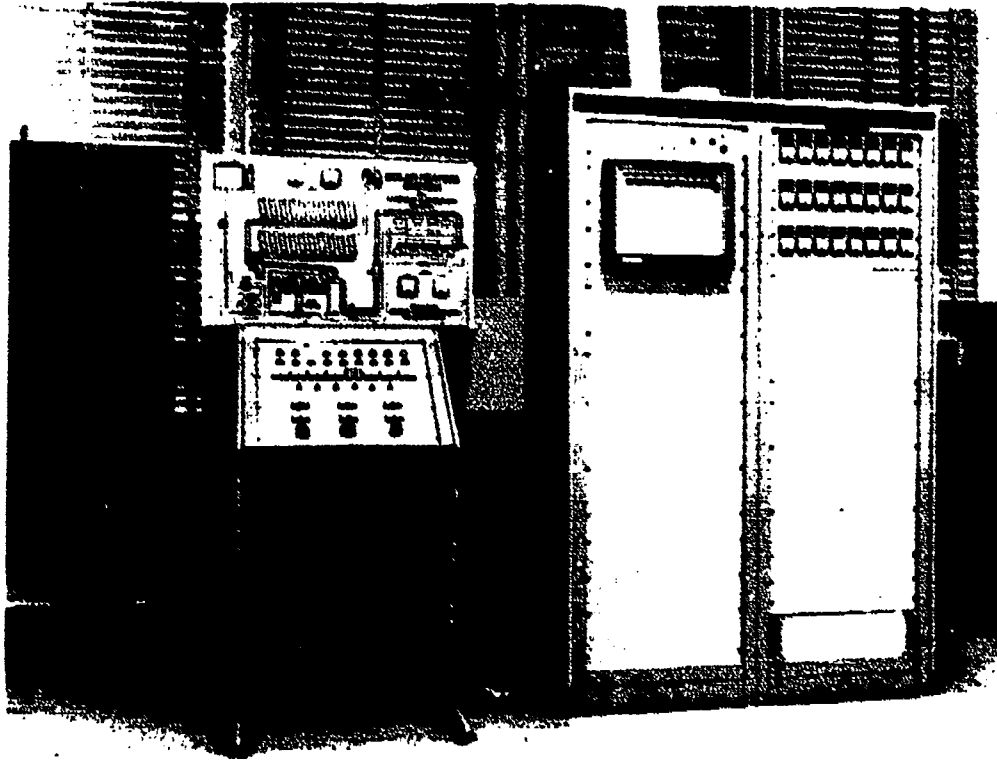

45450

Solar Heating Control Panel and Instrumentation Cabinet  
Figure ES-14

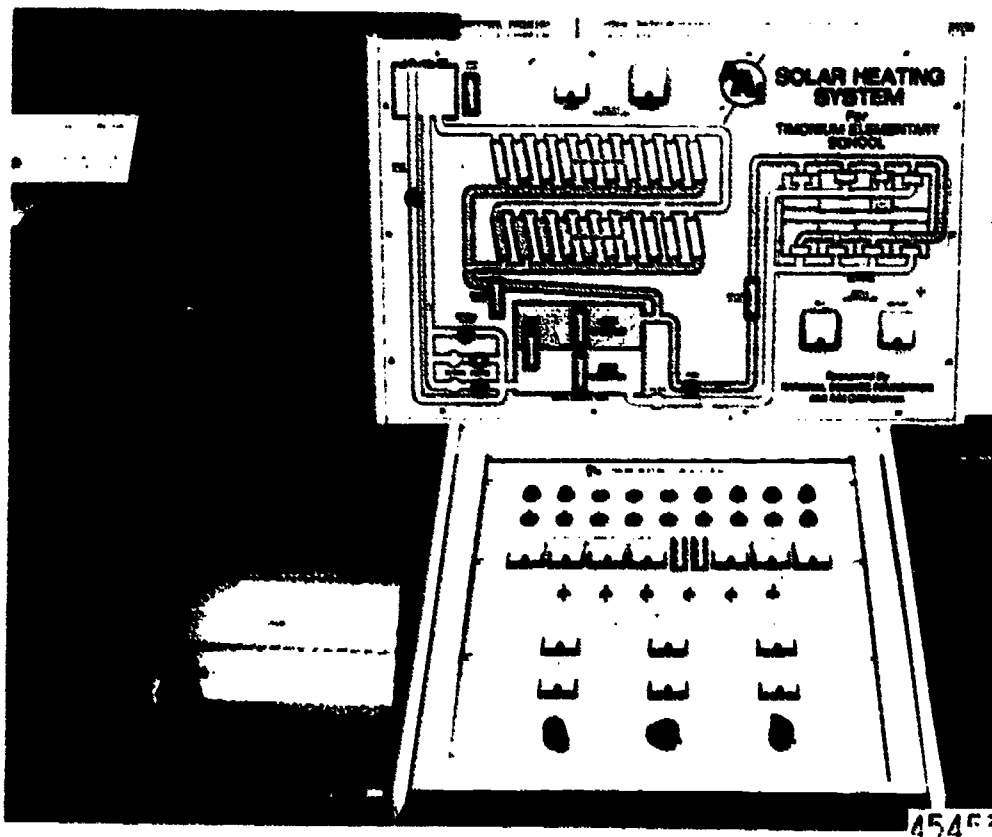

45452

Solar Control Panel  
Figure ES-15



### III. ANALYSIS OF OPERATION

#### A. Direct Operating Costs of the Solar Heating System

Chart ES-16 shown below shows the cost of the electrical energy required to control, collect, distribute, and monitor the solar system.

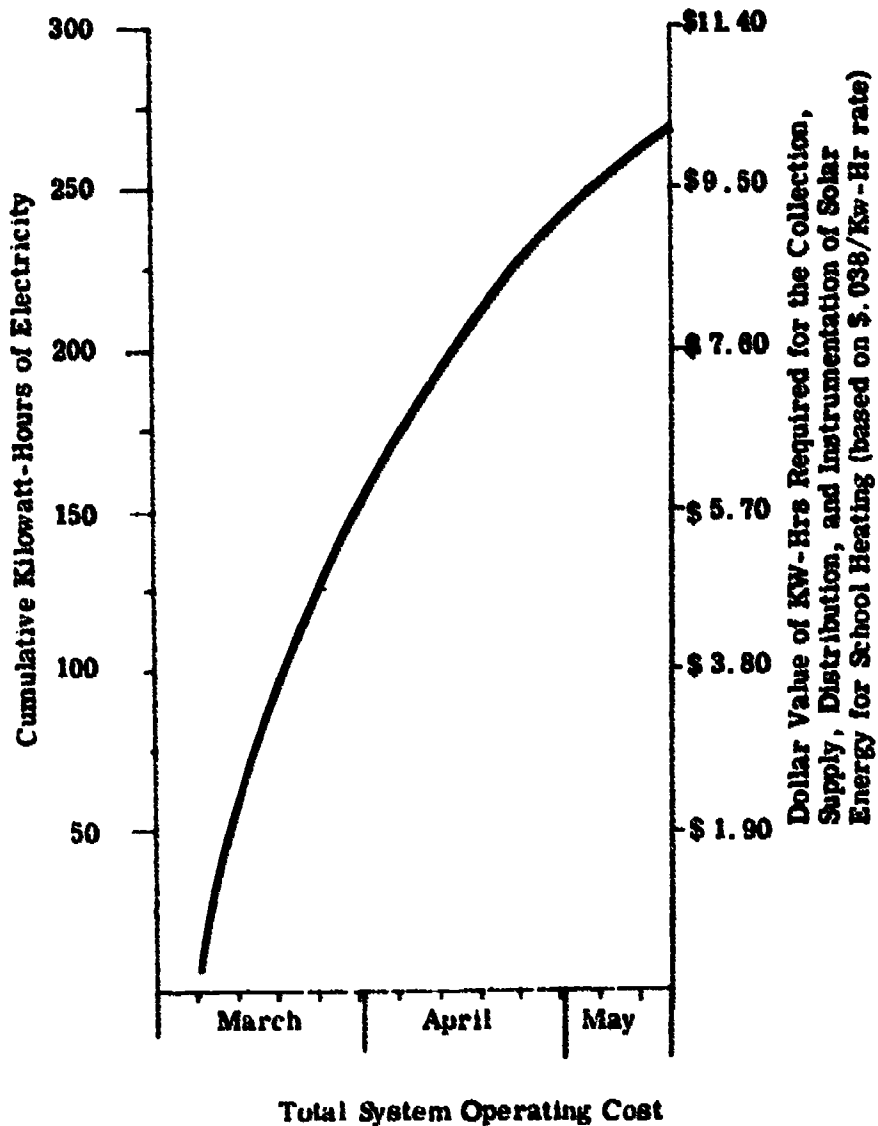

Figure ES-16

The table below lists the equivalent Btu of the watt-hrs consumed for solar collection for solar school heating and for total system instrumentation. The final column lists the equivalent watt-hr. Btu's chargeable to these various categories as a percentage of the total Btu collected.

|                                     | <u>Total Btu<br/>for<br/>Operational<br/>Period</u> | <u>Cumulative<br/>Watt-hours<br/>Expended</u> | <u>Cumulative<br/>Watt-Hrs<br/>Converted<br/>To Btu</u> | <u>Watt-Hr Btu<br/>to Total Btu<br/>Collected<br/>(%)</u> |
|-------------------------------------|---|---|---|---|
| Total Btu Collected                 | $58 \times 10^6$                                    | 205000  | 699665  | 1.2   |
| Btu Utilized for<br>School Heating  | $38.5 \times 10^6$                                  | 50000   | 170650  | .29   |
| Instrumentation for<br>Total System | --  | 14250   | 48635   | .08   |

#### B. Fuel Savings

The utilization of solar heating for the center wing portion of the Timonium School resulted in an overall fuel cost saving to the school for the period of 14 March to 15 May 1974. This cost savings was due to the solar heating system providing 91% of the center wing's heat requirements during this period.

From the school's fuel record the amount of fuel oil consumed by the heating plant was established. This was ratioed to the area heated and it can be shown that approximately 1200 gallons of fuel oil were saved by the use of solar heating for the center wing of the school.

### C. Solar Efficiencies

A chart of solar efficiency versus time of day is shown below. This data is typical for the Timonium Elementary School. It shows how the efficiency rises and falls with insolation (for a given water temperature).

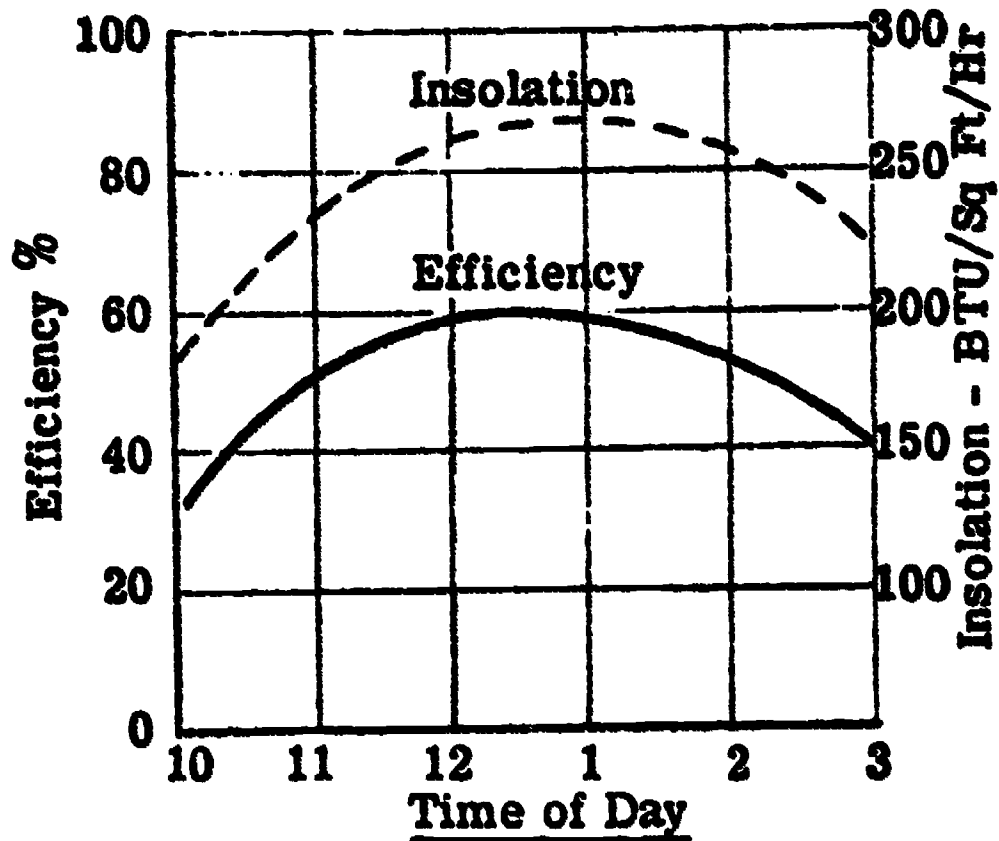

A. M. Inlet Water  $140^{\circ}\text{F}$

P. M. Inlet Water  $147^{\circ}\text{F}$

Outlet @  $156^{\circ}\text{F}$  Avg.

Temp. Ambient  $70^{\circ}\text{F}$  Avg.

April 29, 1974 - No wind,  
Clear

Figure ES-18

#### **D. Heat Input and Output Summary**

**Figure ES-19 shows a typical day's operation in a Solar Heated school. Note that little or no heat is expended heating the school during the hours of 9:00 A.M. and 4:00 P.M. when the school is occupied by the students. Most of the school heating occurs at night and in the early morning hours.**

**Figure ES-20 displays a weekly history of the operational performance of the system. Very apparent is the large number of BTU's collected at system start-up when the water temperature was relatively cold.**

**A summary of the total system Heat Input and Output during the operational period of the system is shown in Figure ES-21.**

**About 7 million BTU's were held in reserve in the storage tank after its temperature reached 150°F. Since the average daily heat required for the school is 1,000,000 BTU's (during the March to May period), the tank is holding about 5.75 days reserve heating capacity (allowing for radiation losses).**

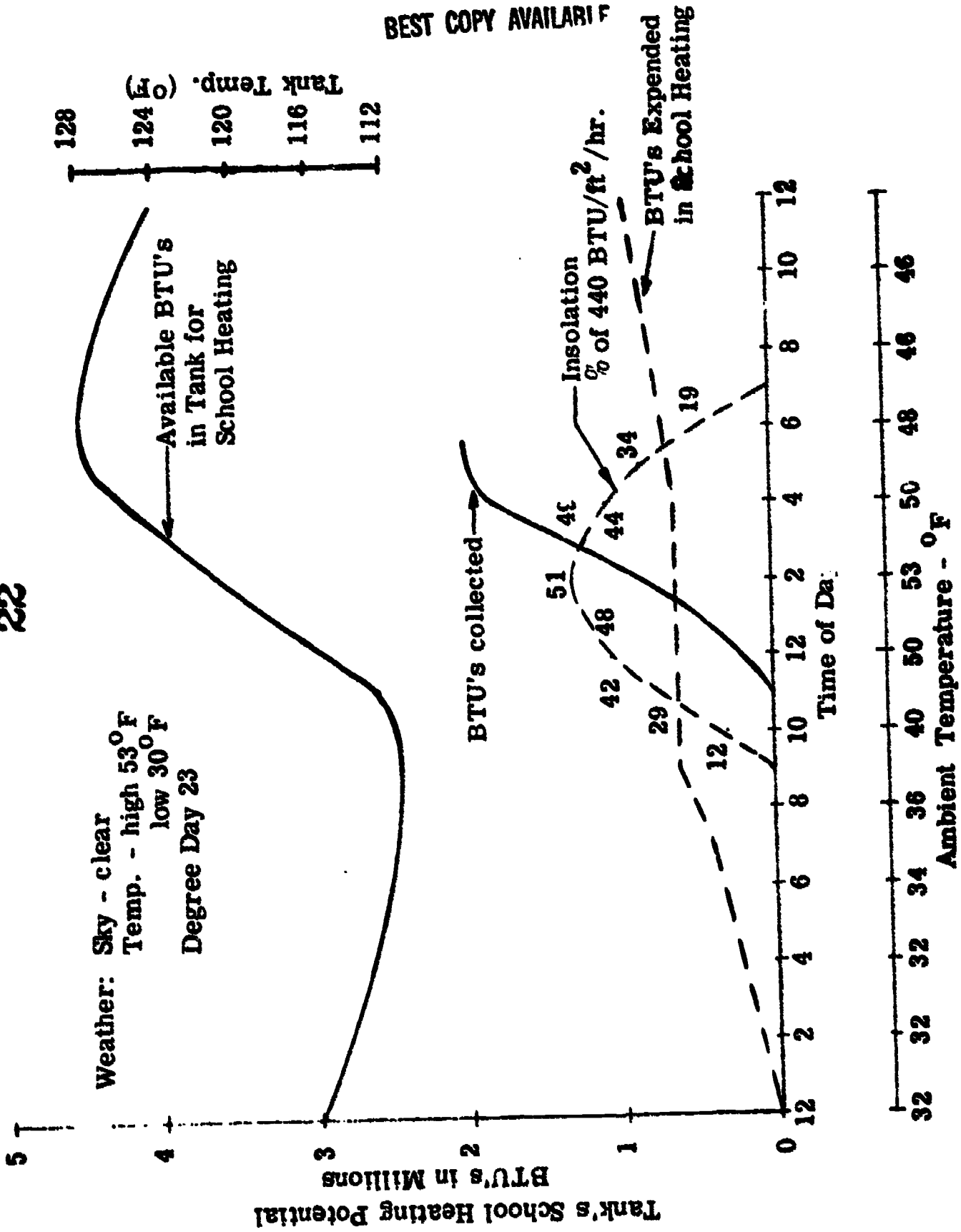

Typical Day's Operation of the Timonium Solar Heating System

Figure ES-19

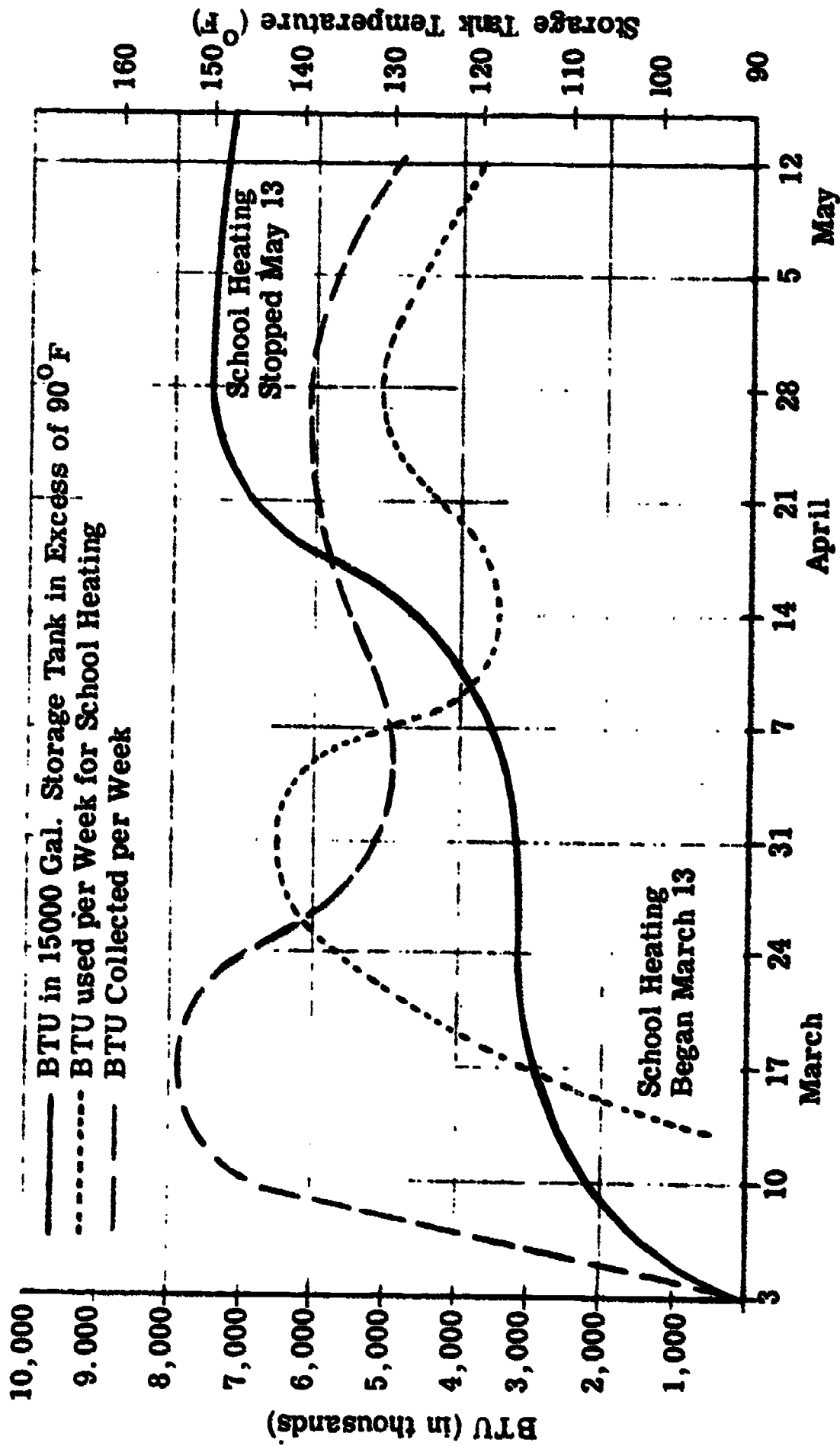

Operational Performance of the Timonium Solar Heating System  
For the Period of March 1974 to 15 May 1974

Figure ES-20



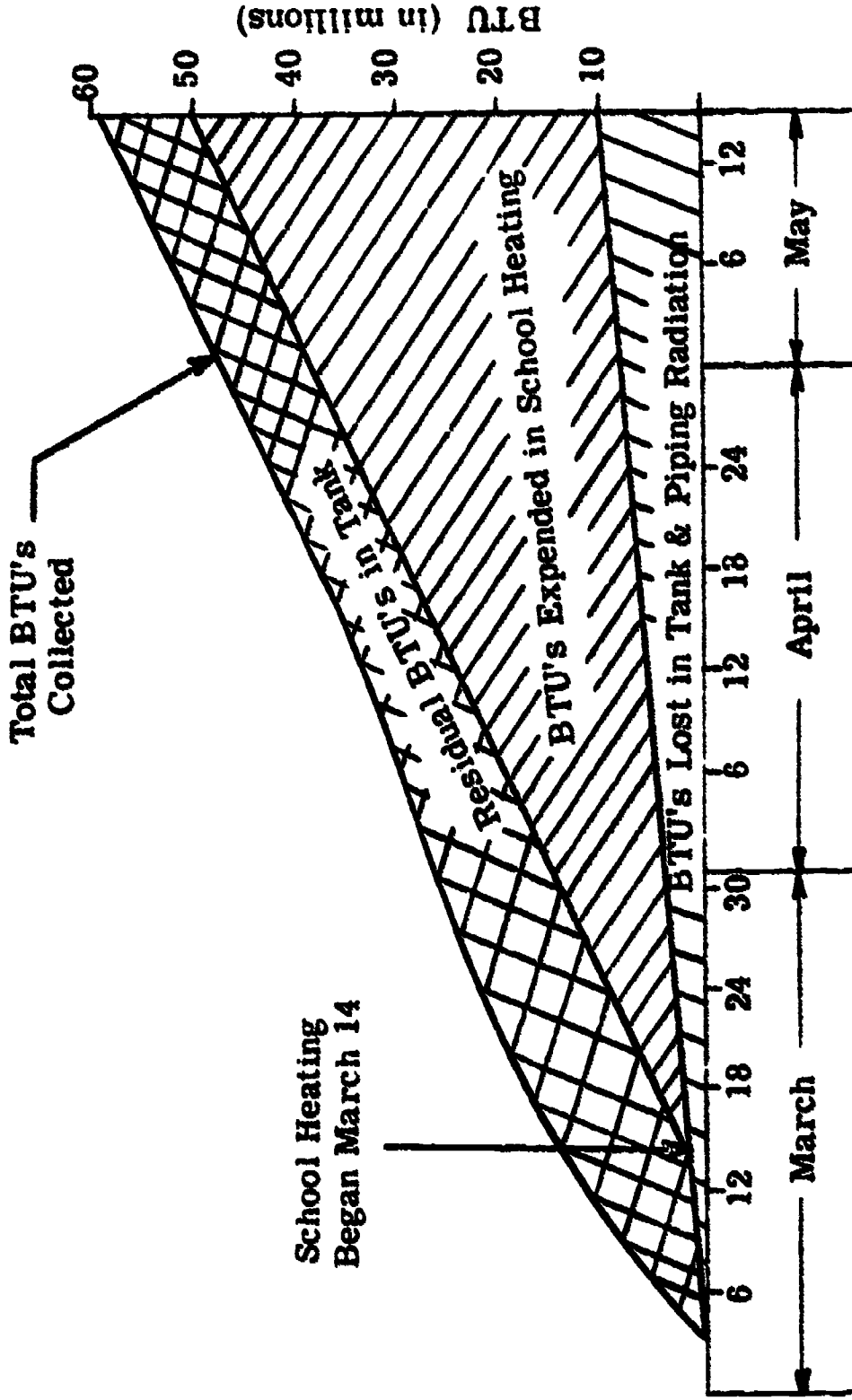

Total System Heat Input and Output  
During the Operational Period of the System

Figure ES-21

#### **IV. RECOMMENDATIONS AND CONCLUSIONS**

##### **A. Recommendations for Modifications to the System to Improve Performance or Producibility in Order to Permit Widespread Applications of Solar Heating to School Buildings**

After only 2-1/2 months of heating system operation, it is too early to make large scale recommendations for modifications. However, many detail changes are suggested in the main body of the report. These concern:

- o Increased insulation for pipes
- o Improved solar collector efficiency
- o Improved plumbing systems
- o Use of reflectors for increased summer performance.

##### **B. Conclusions as to the Generalizability of the Results Obtained**

1. Based on only 2-1/2 months of operation, only a small portion of the results obtained are generalizable at this time. These are the efficiencies, heat losses, heat requirements of schools per degree day, etc.

2. The cost studies of the capital investment for the system when projected for additional retrofit installations and for new school construction indicate the following:

###### **a. Retrofitting Schools for Solar Heating**

By 1985 the retrofitting of schools in Maryland and farther north will be economically feasible. This will be made possible by the increasing cost of fossil fuels.

For areas of the southwest and south, the additional Btu's available from increased insolation will make retrofit more feasible in the current timeframe.



**b. New School Solar Heating**

**If the cost of fuel oil remained constant, a total installation cost per square foot on new construction would have to be below \$5.00/Ft.<sup>2</sup> for an amortization of 25 years at low interest.**

**If the cost of fuel doubled in 10 years, then the price per square foot could double to \$10.00/Ft.<sup>2</sup> for total installation now.**

**Present indications are that the system installed on new schools in 1975 would cost from \$9.00 to \$13.00 per square foot.**

## **I. INTRODUCTION**

On January 14, 1974, AAI Corporation received Contract Number NSF-871 from the National Science Foundation to conduct a Solar Heating Proof-of-Concept Experiment (POCE) for a public school building. On March 1, 1974, one and a half months later, the experiment began as Timonium Elementary School became the first school in the United States heated by solar energy. In this brief period of time, AAI designed, manufactured, and installed a 5000 Ft<sup>2</sup> collector array complete with mounting trusses, a 15,000 gallon water storage tank, school hot water heating system, and instrumentation.

From March 1 to May 15 the selected wing of the school received 90% of its heat from the solar heating system. During this period, experimental data was collected and is presented in this report.

This experiment has been successful since it has proven that the solar heating of schools is possible, practical, and socially acceptable. In addition, over 1200 gallons of fuel oil have been saved in the brief period the system has been in operation.

This report describes the system in detail, presents the analysis of operation, and discusses recommendations and conclusions based upon the results of the experiment so far.

## **II. GENERAL DESCRIPTION OF SYSTEM**

### **A. Timonium Elementary School**

The Timonium Elementary School located at 2001 Eastridge Road in Timonium, Maryland was chosen as the site for the AAI Proof-of-Concept Experiment. This school is representative of many United States schools, and is one of more than 300 in the state of Maryland. It is basically a one-story school with window walls on one side of each room.

Figure 2-1 shows an artist's concept of the school. The center wing was chosen for the solar experiment. The heating requirements for the other two wings, heated by oil-fired boilers, could then be compared to the wing heated by solar energy. The total area of the school is 60,000 square feet and the area of the solar heated wing is 10,000 square feet.

The solar heating system, as built for the Timonium Elementary School, meets all structural and safety requirements. The design was approved by the Baltimore County School System.

Figures 2-2 and 2-3 show the external view of the center wing before and after the installation of the solar heating system.

An overall view of the solar heating system applied to the school can be seen in Figure 2-4.

BEST COPY AVAILABLE



AA968

Artist's Concept of Timonium Elementary School

Figure 2-1

29



Center Wing of Timonium Elementary School Before  
Installation of the Solar Heating Experiment

Figure 2-2



Center Wing of Timonium Elementary School After  
Installation of the Solar Heating Experiment

Figure 2-3

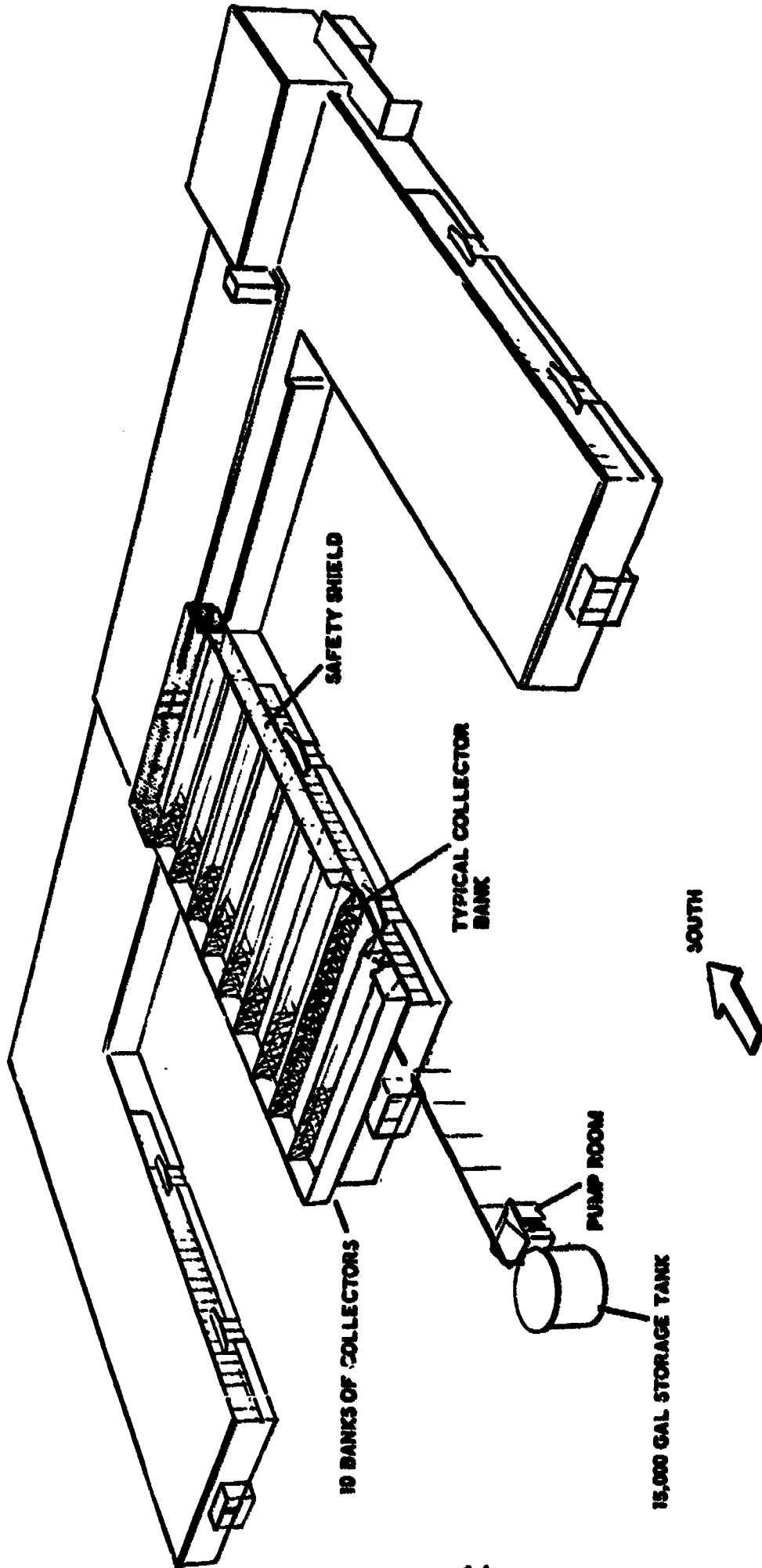

Solar Energy Experiment  
Timonium Elementary School

Figure 2-4

## **B. Solar Collectors**

The basic construction of the AAI collector is as follows.

The collector has two glass covers made from double-strength, low iron content glass. Two thicknesses of aluminum honeycomb are used between the two glass covers and the aluminum absorber plate. Notches are cut in the honeycomb before it is extended as shown in Figure 2-5. The glass plates, the honeycomb, and the absorber plate are bonded together with a two-part epoxy adhesive. A one-and-one-half inch (1-1/2") thick polyurethane foam sheet of insulation is bonded to the back of the absorber plate. After polyurethane foam edging is applied, a rubber strip is applied to the edges of the collector as shown in Figure 2-6.

A stack of finished collectors is shown in Figure 2-7.

The AAI collector is 4 feet by 7 feet by 2-3/8 inches thick, and weighs about 90 pounds (see Figure 2-8).

One hundred and eighty collectors were installed on the roof of Timonium Elementary School. They were lifted to the roof on a pallet as shown in Figure 2-9.





45251

Sawing Water Slots in the Unexpanded Honeycomb

Figure 2-5



Installing Neoprene Rubber Edging Strip  
On the Collectors

Figure 2-6



Fabricated Solar Collectors

Figure 2-7

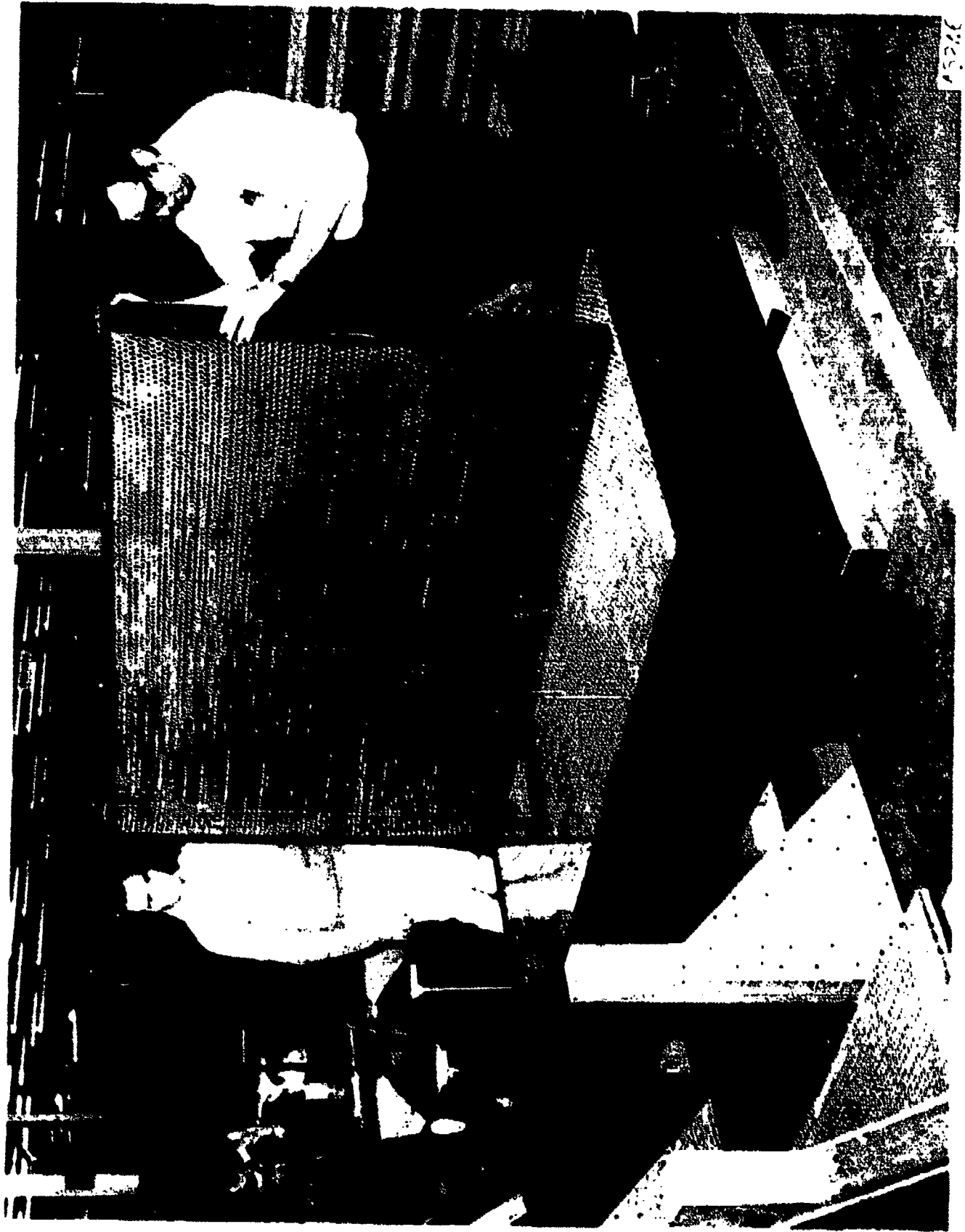

Solar Collectors in Manufacturing Area

Figure 2-8

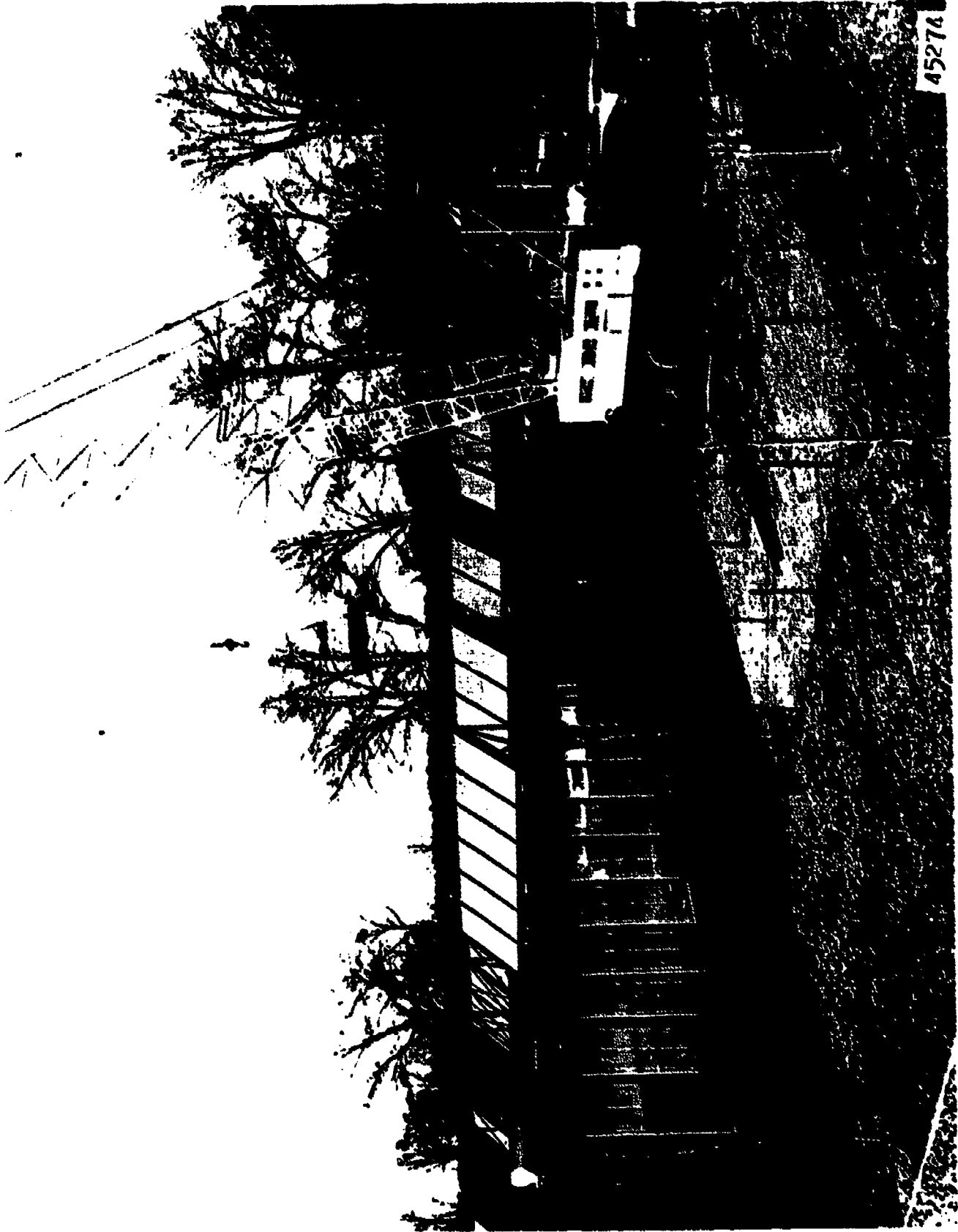

Lifting the Collectors to the School Roof  
Using a Pallet and Crane

Figure 2-9

**Figure 2-10 shows the ten rows of eighteen collectors after they were installed on the roof, but before the plumbing was installed.**

**Water is fed to the collector from the top, through a rubber hose. The bottom hose connection can be seen in Figure 2-11.**

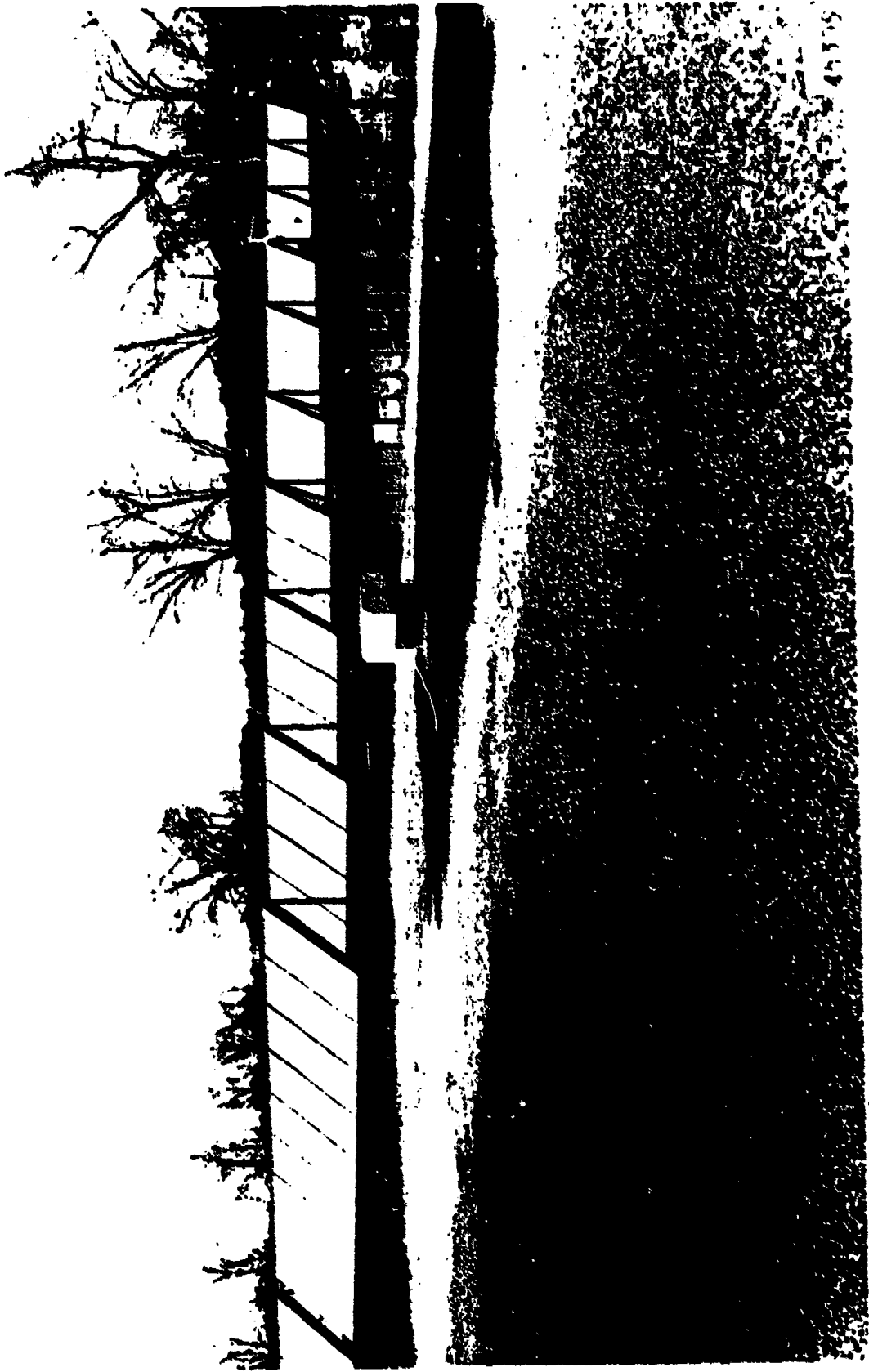

Collectors Mounted on Roof Before Installation of Plumbing

Figure 2-10



Collector Hose Being Installed into Drain Line

Figure 2-11  
**41**



### **C. SUPPORTING STRUCTURE**

The solar collectors are mounted on ten steel trusses which are bolted to I-beams which in turn sit on steel posts. The structural details are shown in the Appendix, Dwg. Nos. 57413-40042 and 57413-40041.

The appearance of the roof before installation is shown in Figure 2-12.

The steel trusses were fabricated in the weld shop at AAI Corp. They were painted with a zinc chromate rust preventative before being moved to the school site.

Figure 2-13 shows several trusses stored at AAI before being transported to the school site.

The trusses were lifted to the roof with a crane as shown in Figure 2-14.

The finished structure with collectors installed is shown in Figure 2-15. The relationship between the truss, I-beam, and mounting post can be clearly observed.

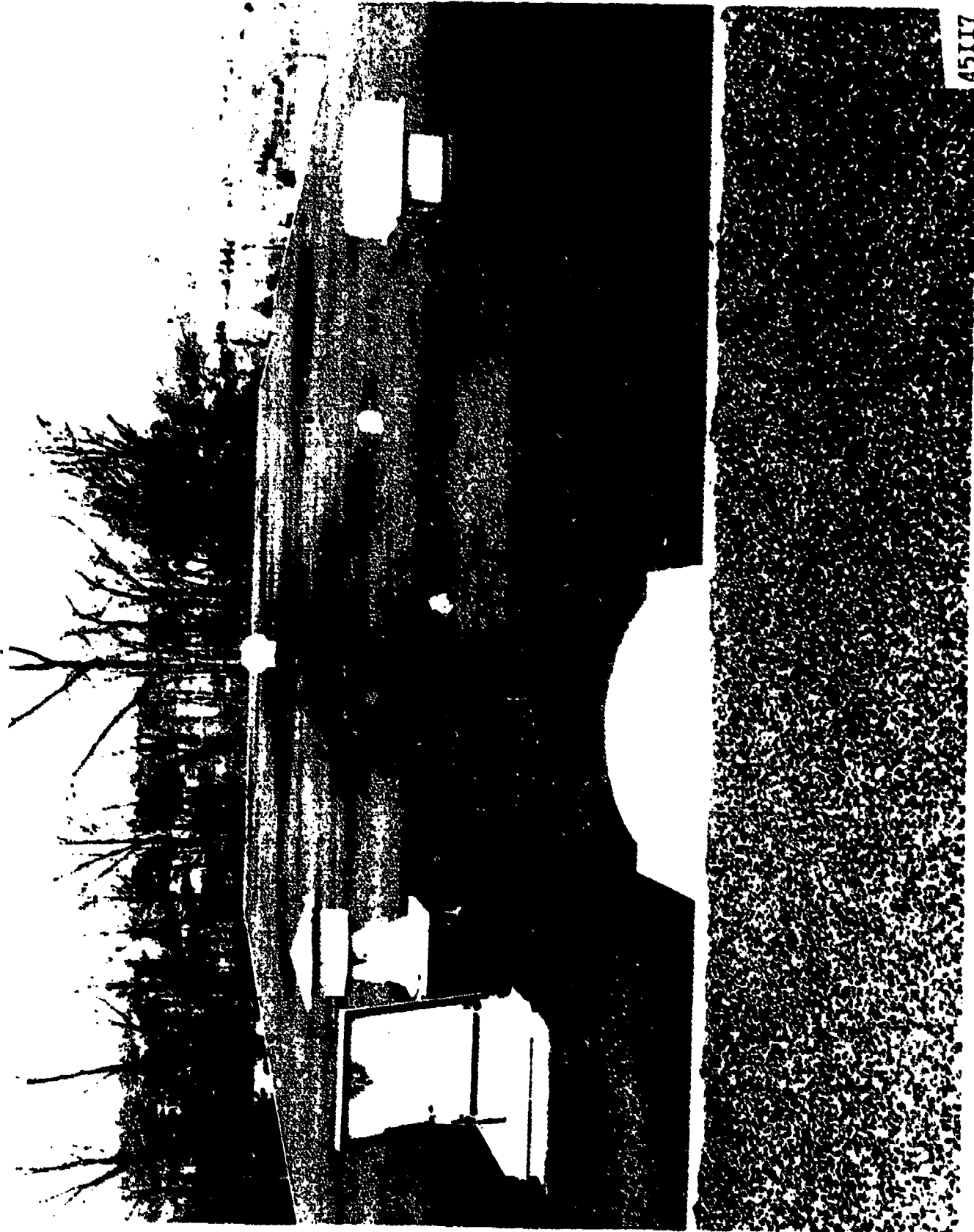

45117

Roof of School Before Solar Heating Installation

Figure 2-12



45247

Trusses Stored at AAI Before Shipment to School

Figure 2-13

BEST COPY AVAILABLE



45270

Truss Being Lifted to Roof

Figure 14



Installed Trusses with Collectors

Figure 2-15

#### **D. Collector Plumbing**

An artist's concept of the solar plumbing arrangement is shown in the Appendix on Dwg. No. 57413-40120. It shows that the water is pumped up to a small head tank and distributed to the tops of the collectors from that point. Gravity thus supplies the pressure to the water supplied to the collectors. The water then flows through the collector and over the absorber plate. It then drains into the return line and flows back to the storage tank.

Aluminum pipes were used throughout the collector system to minimize the effects of dissimilar metals causing galvanic corrosion. One and one-half (1-1/2) inch thick polyurethane foam insulation was applied to the pipes. This was covered with black building paper to protect it from the weather.

A schematic of the pumps, valves, and filters required for the system is shown in the Appendix, Dwg. No. 57413-40024.

The pumps, valves, and filters are located in the pump house shown in Figure 2-16.

An internal view of the pump house is shown in Figure 2-17. The school convector pump is in the foreground, the Culligan water deionizer is on the right, and a water filter is on the left.

The water supplied to the system passes through the Culligan water treatment system which deionizes the water, thus reducing chances of corrosion.

**The Culligan water-conditioning system that was incorporated into the Timonium Solar Heating System was reviewed with and recommended by local industrial concerns who had experienced the corrosion type problems that are generally associated with hot water heating systems. The Culligan deionization system that was selected utilizes a strong base duo-bed deionization system to demineralize the water and was selected for the following reasons.**

**This system would produce a large volume of high quality water at a low cost. Deionized water would eliminate build-up of deposited minerals in the panels due to the excessive heat. Since a lower total dissolved solids water has a lower boiling point than a higher total dissolved solids water, the water would heat faster, thus creating a more favorable situation for the operation of the Solar System.**

**From a systems standpoint, the portable exchange deionizers were easily adapted to the job site (requiring little space) and were easily piped to the system. As the Solar System required make-up water the deionizers were always there to provide a high quality water. The water coming from the deionizers would have a 7.5 - 8.0 pH, thus assuring a non-corrosive water.**



45457

External View of Pump House

Figure 2-16

19

BEST COPY AVAILABLE



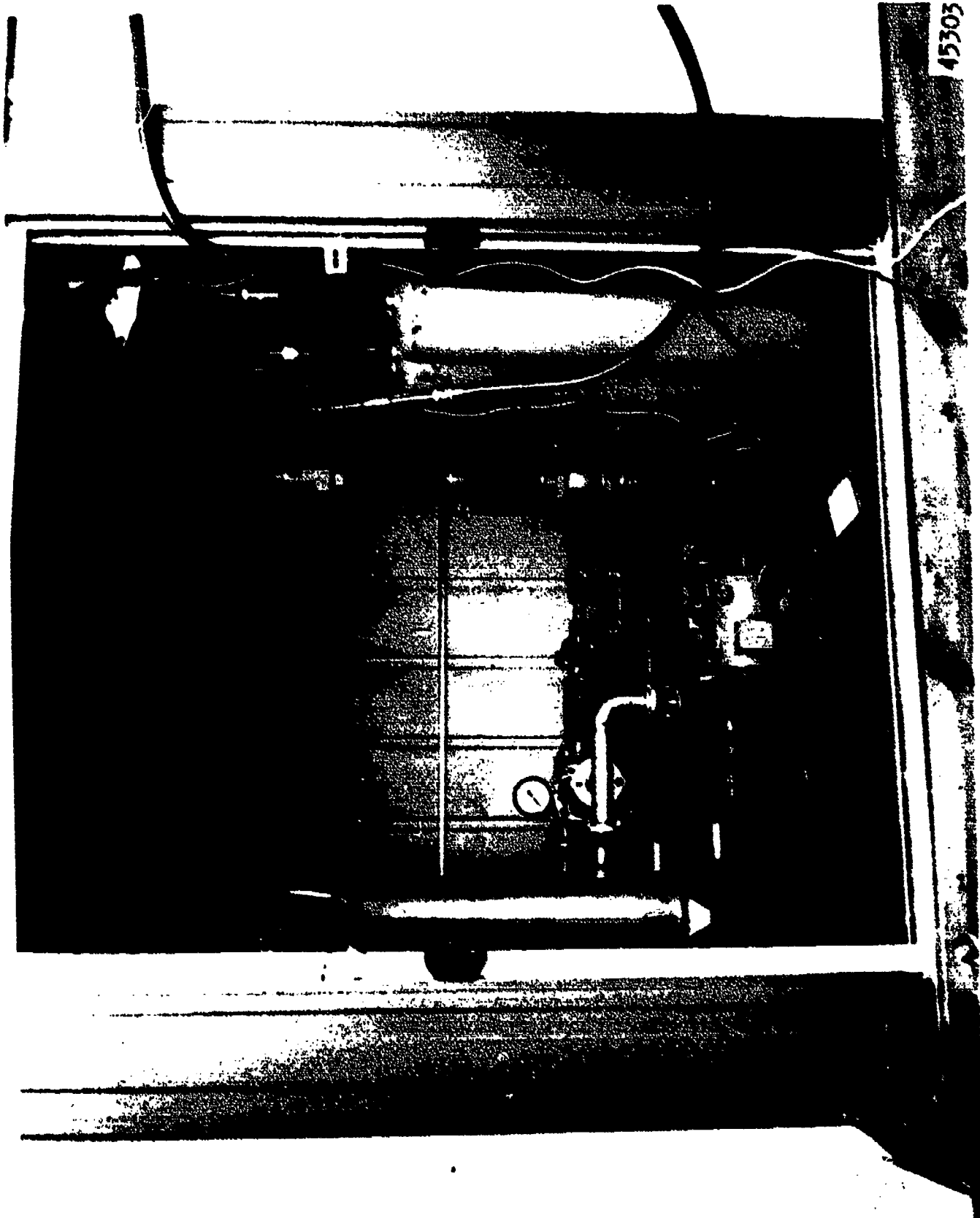

45303

Internal View of Pump House  
Figure 2-17

BEST COPY AVAILABLE

### **E. School Convectors (Unit Heaters)**

The Timonium Elementary School is normally heated by steam with the two boilers shown in Figure 2-18. One of these boilers is usually in the standby status.

The steam supplies heat to the school rooms by passing into a standard heating and ventilating unit as shown in Figure 2-19. This unit, controlled by the room thermostat, supplies steam-heated air as well as ventilating air from the outside. The outside vent for the unit is shown in Figure 2-20.

The solar heating system designed for the center wing of the school used hot water forced air convectors. A separate parallel hot water piping system was designed to supply hot water from the storage tank to twenty convectors of the type shown in Figures 2-21 and 2-22.

A layout of the convectors and their associated plumbing is located in the Appendix, Dwg. No. 57413-40114.

All pipes for the school convectors were insulated with one inch of polyurethane foam.

The solar convectors are controlled by the existing thermostats located in each room of the wing.

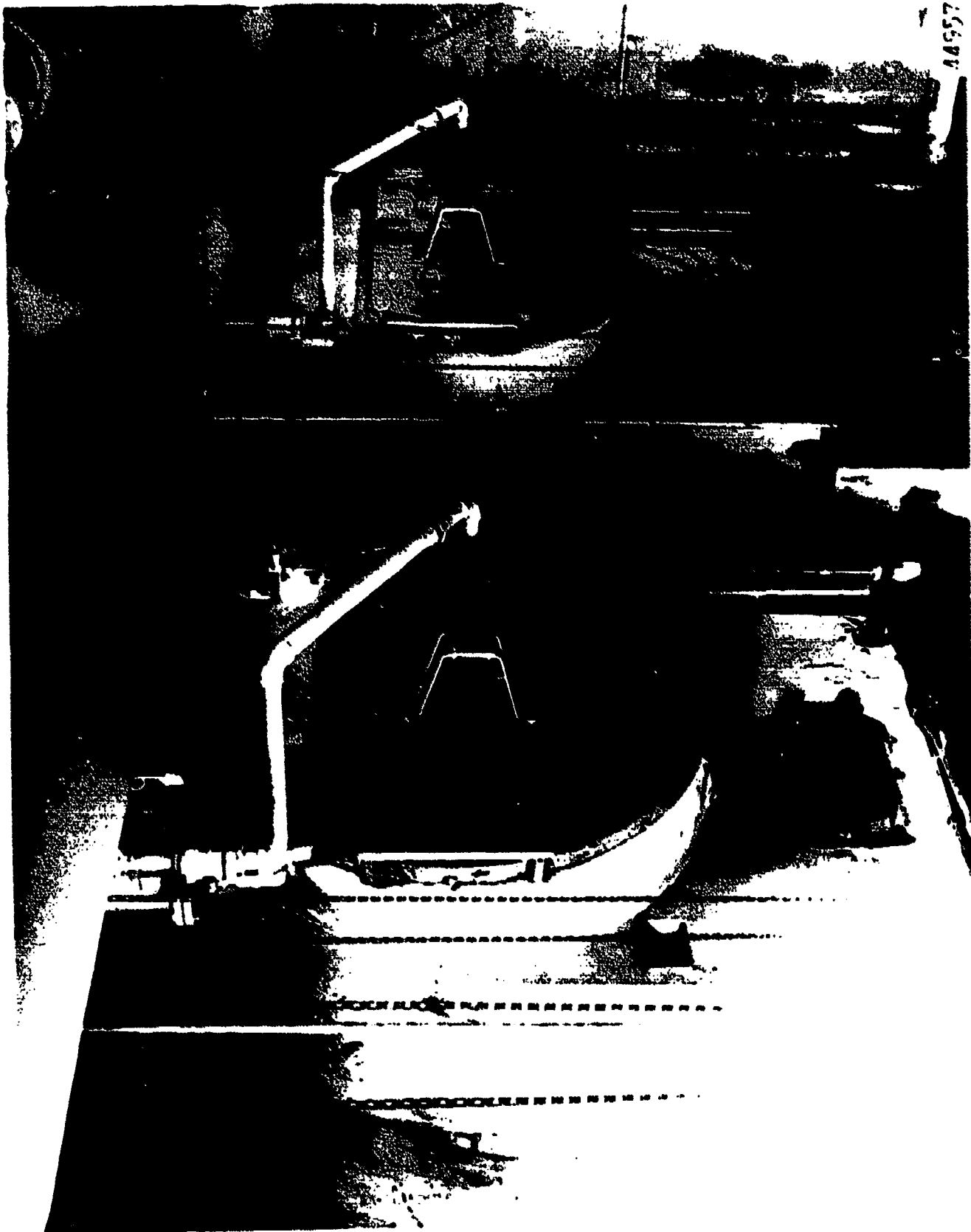

AA957

Steam Boilers Used for Heating  
 Timonium Elementary School

Figure 2-18



Heating and Ventilating Steam Unit  
With Protective Cover Removed

53 Figure 2-19

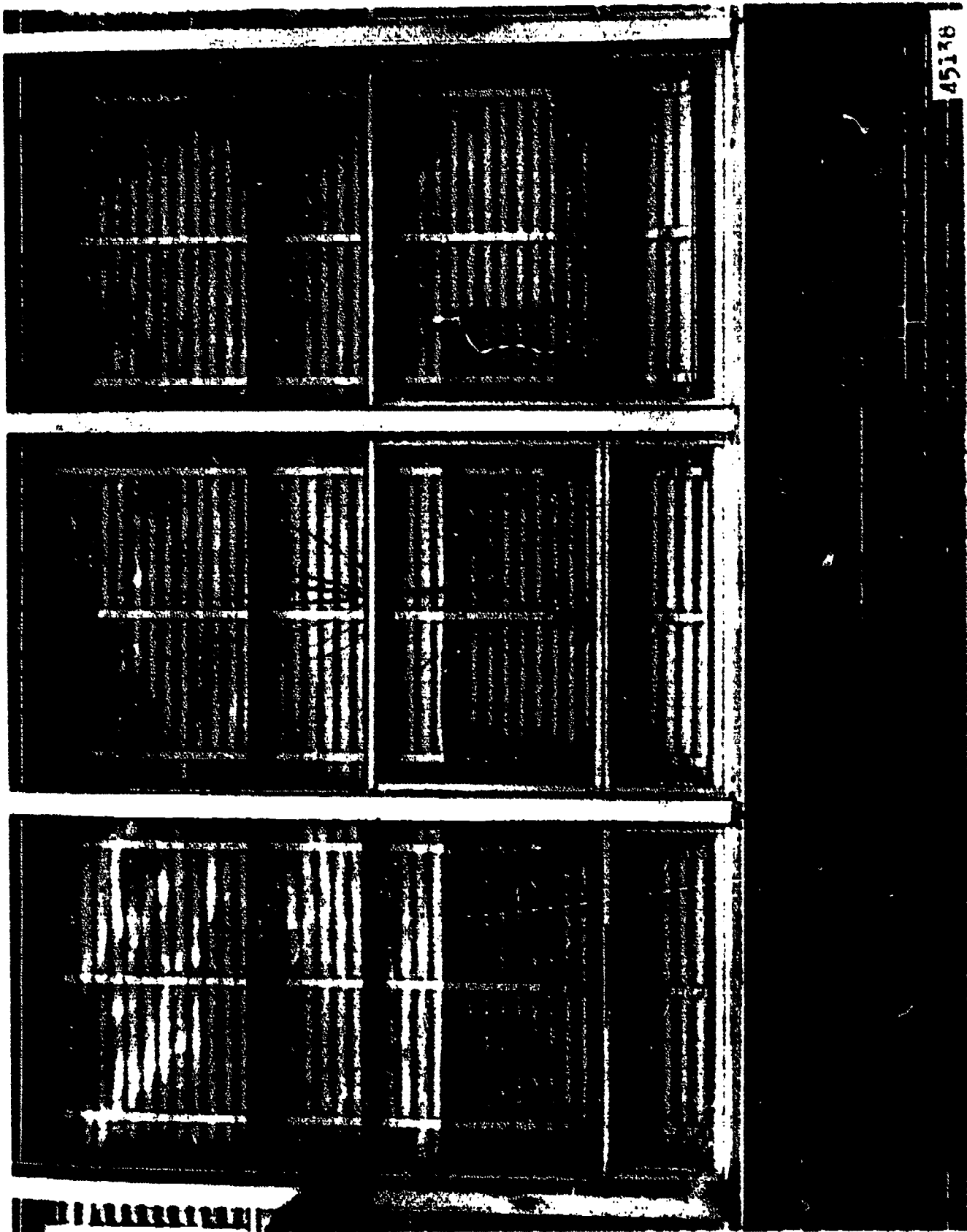

View of Typical Ventilation Opening for the Heating and Ventilating Steam Unit

Figure 2-20

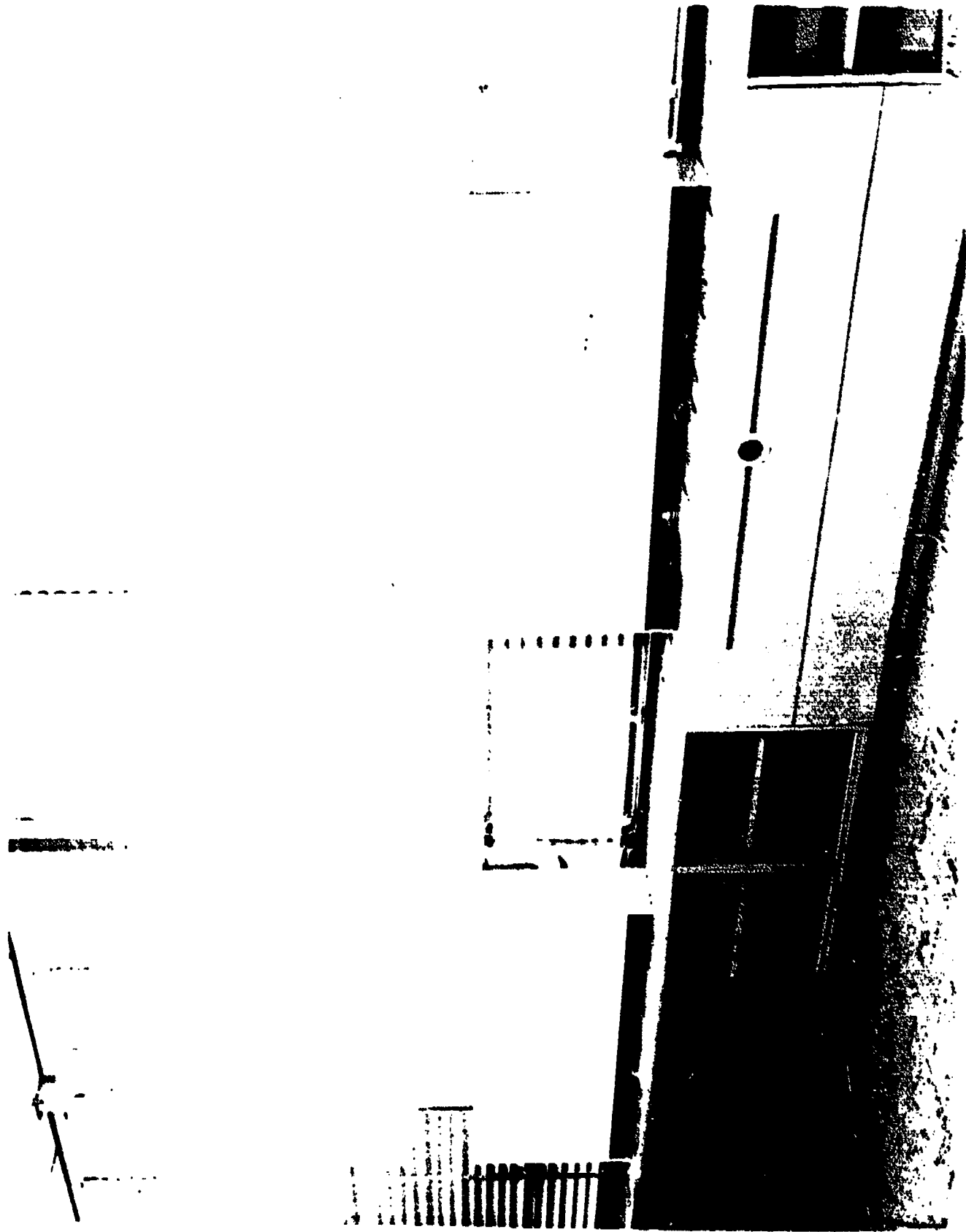

Two of the Solar Hot Water - Forced Air Convectors  
(Two convectors were used in the average 1050 Ft<sup>2</sup> classroom)

Figure 2-21



Solar Hot Water - Forced Air Convectors  
Mounted in the Ceiling of the Library

Figure 2-22

45454

## **F. Storage Tank**

A 15,000 gallon capacity storage tank was designed for the system. It provides 3 gallons of storage per square foot of collector area.

The construction details of the tank may be seen in the Appendix, Dwg. No. 57413-40032, Sheets 1 and 2. It is constructed solely from 6061-T6 aluminum. The sides are rolled and welded. Rolled channels are welded to the sides for lateral support.

A separator is located in the middle of the tank to aid in stratification.

Figure 2-23 shows the tank in the AAI Corp. welding shop. The tank was transported to the site by truck as shown in Figure 2-24 and moved into position by crane as can be seen in Figure 2-25. A reinforced concrete pad was prepared to support the tank which weighed about 5,000 pounds empty, and 125,000 pounds filled with water. The tank was insulated as follows:

- Top:** 4 inches of fiberglass batts covered with 1/2 inch of asphalt and a steel mesh grid.
- Sides:** 4 inches of fiberglass batts covered with an .040" thick aluminum cover.
- Bottom:** 6 inches of polyurethane foam encased in a redwood lattice.



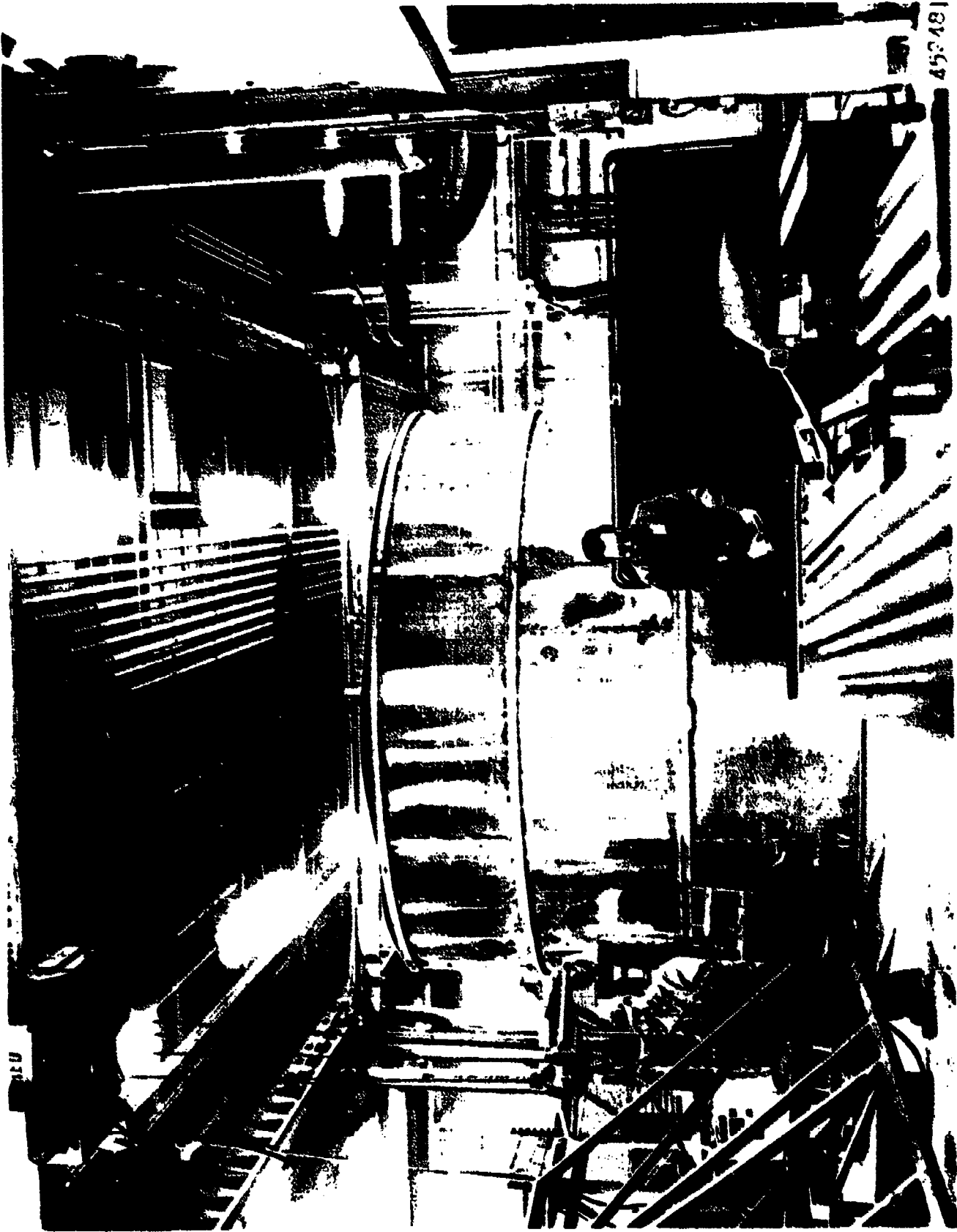

453481

Storage Tank in the Weld Shop  
Trusses are Shown on the Left

Figure 2-23

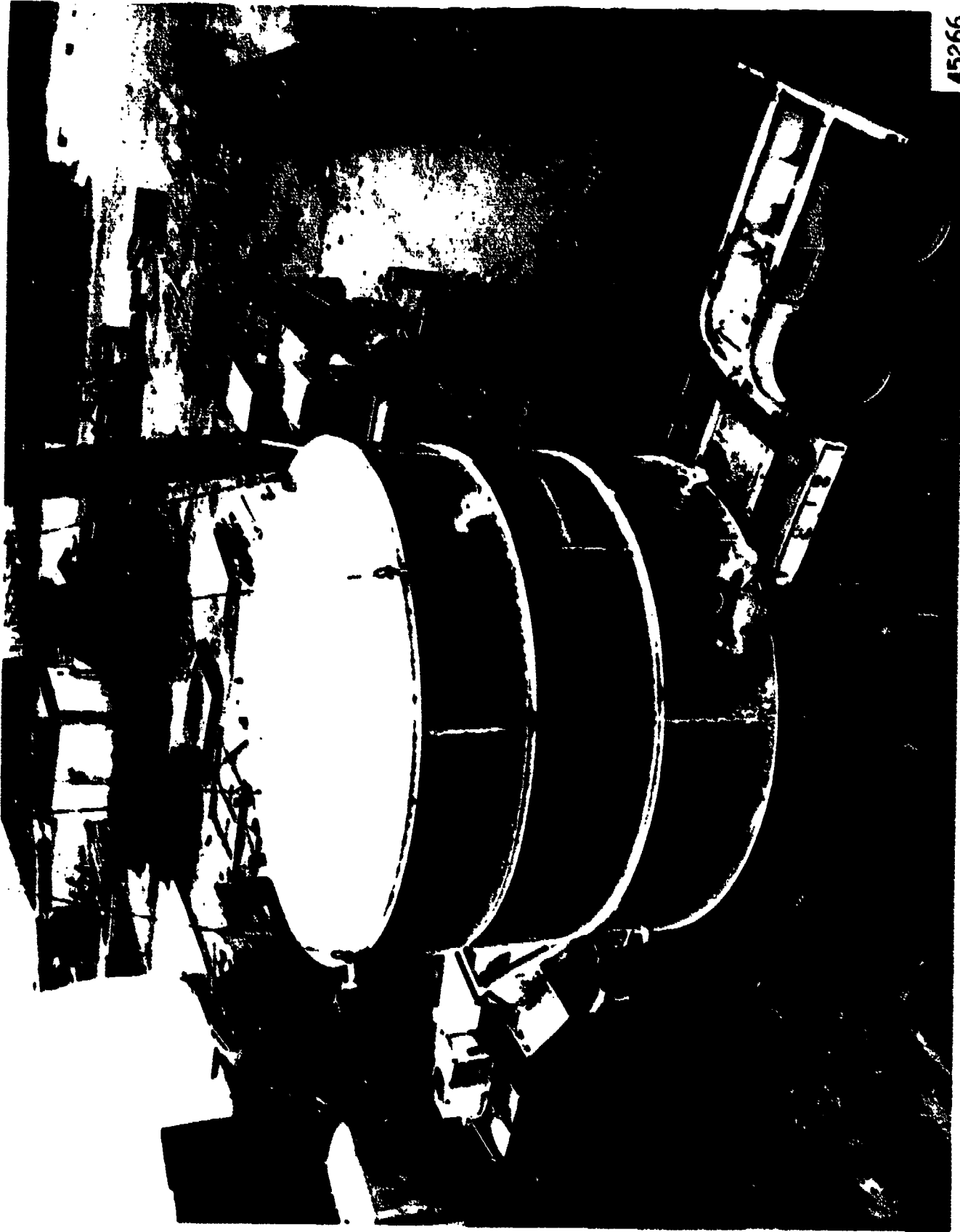

45266

Storage Tank Loaded on Truck for Delivery to Site

Figure 2-24

59



45271

Storage Tank Being Lowered Onto Its Pad by Crane

Figure 2-25

**This insulation is designed to limit the temperature loss to 1° F in 24 hours.**

**Figure 2-26 shows insulation being applied to the solar collector pipes and the storage tank.**

**The fully insulated tank is shown in Figure 2-27.**

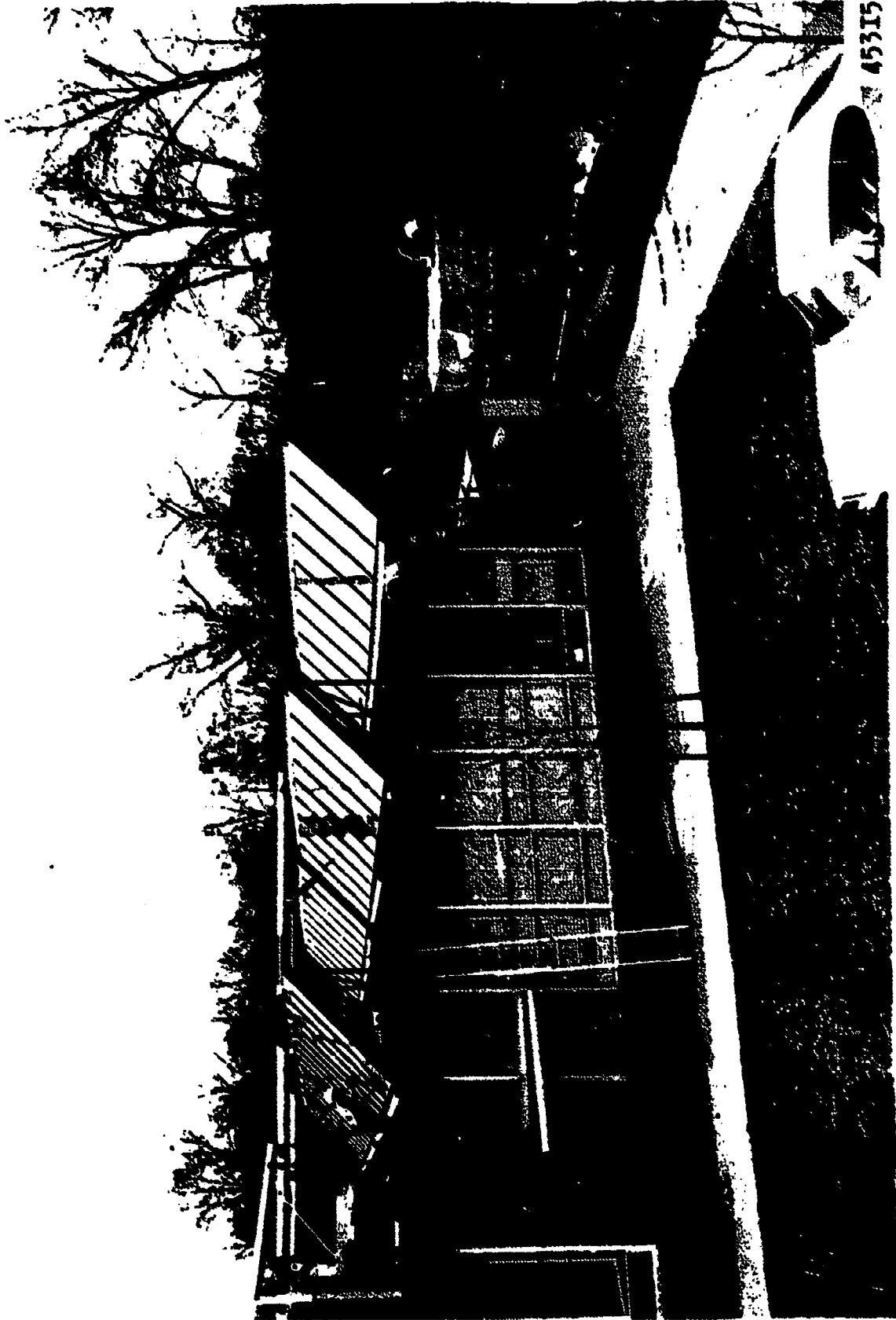

Insulation Being Applied to the Solar Collector  
Pipes and the Storage Tanks

Figure 2-26

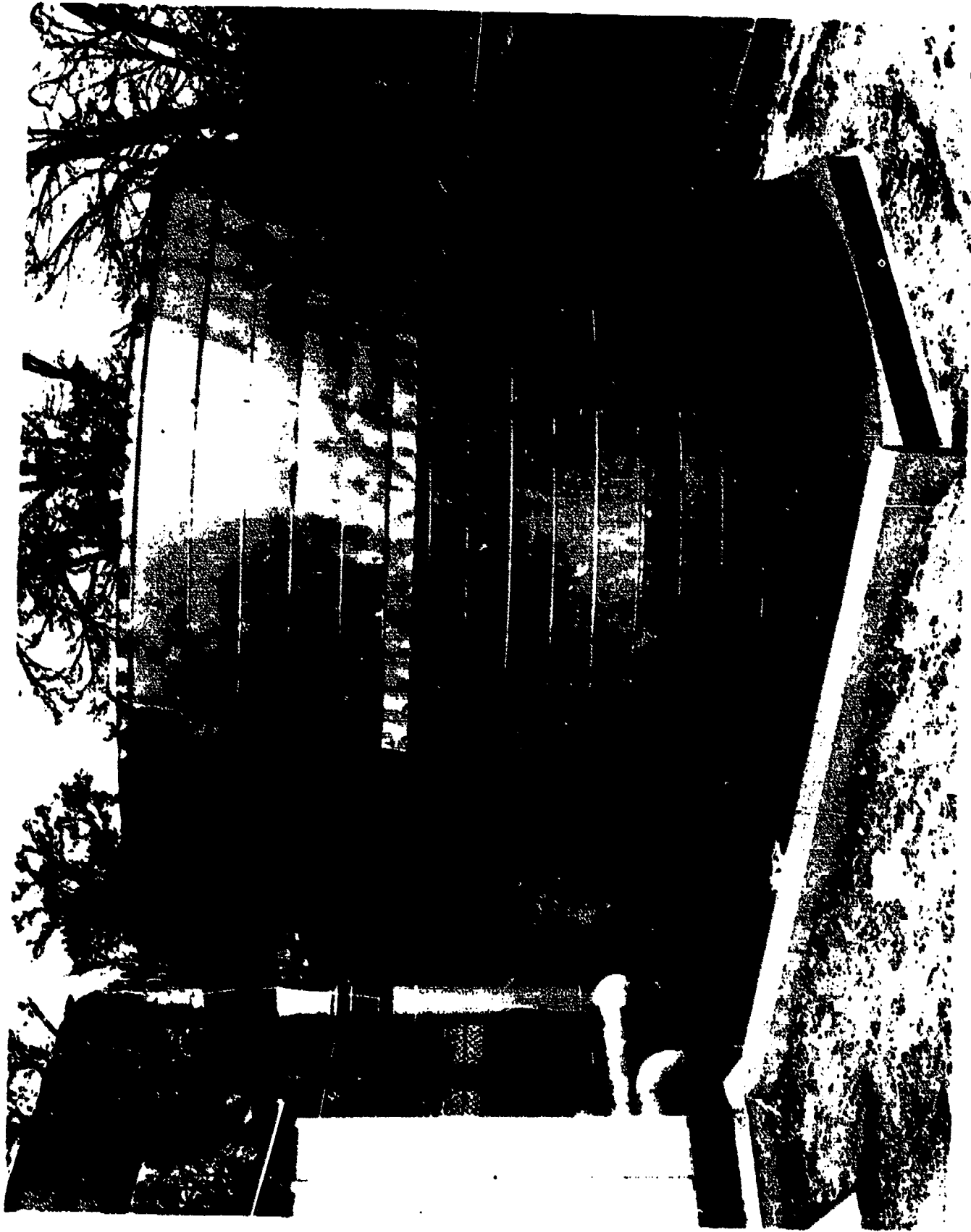

45425

BEST COPY AVAILABLE

Fully Insulated Tank

Figure 2-27

## **G. Instrumentation**

The instrumentation for the system is located in the end room of the heated wing. An overall view of the instrumentation is shown in Figure 2-28. The console on the right houses the Leeds and Northrup recorder which continuously monitors thirteen items.

Figures 2-29 and 2-30 show close-up views of the control panel.

Chart 2-1 shows a detailed listing of all points of instrumentation being monitored.

A complete schematic and layout of the instrumentation can be found in the Appendix, Dwg. No. 57413-40069, Sheets 1 and 2.

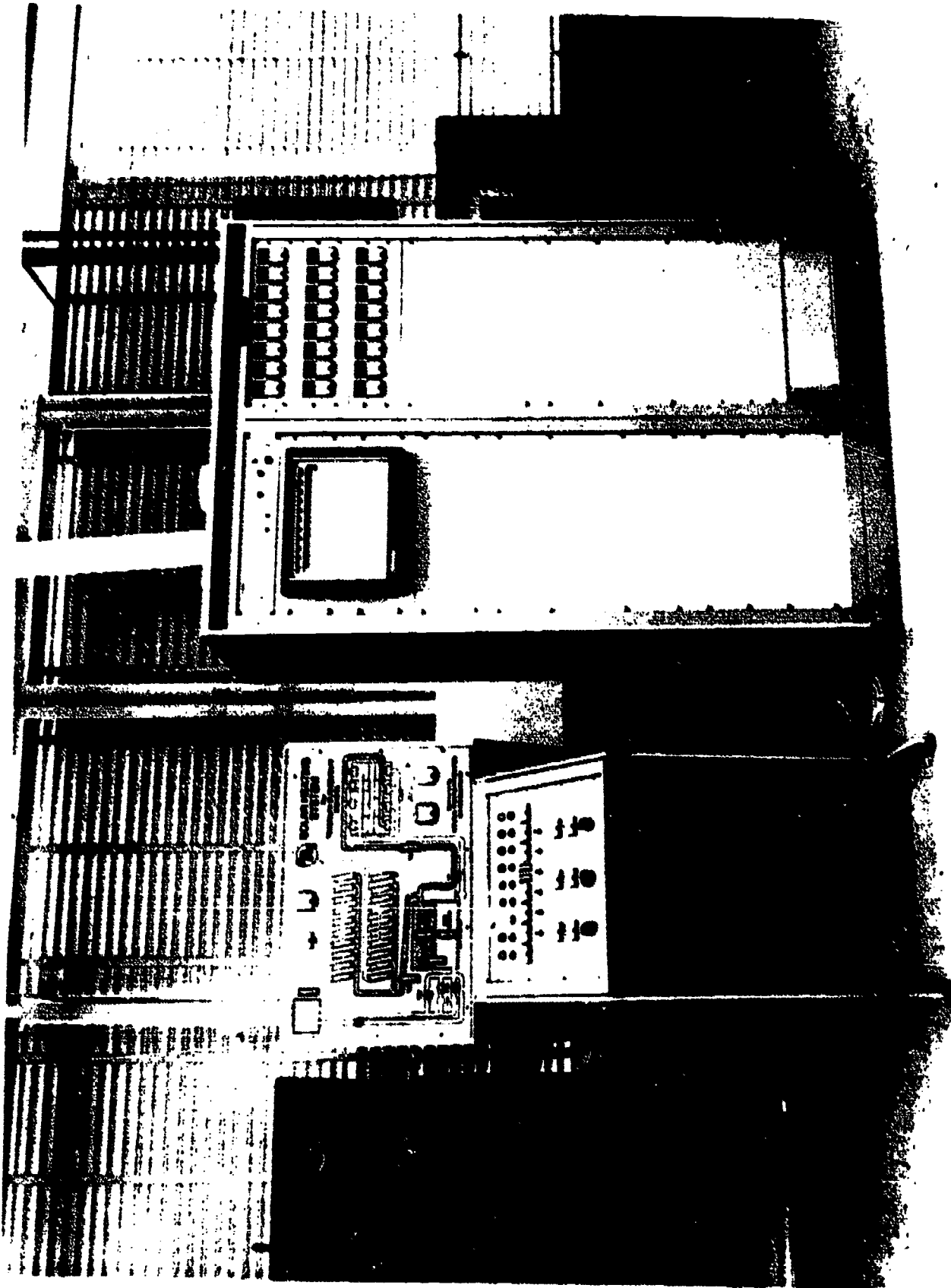

Overall View of the Instrumentation and Control Panels

Figure 2-28  
65

ERIC



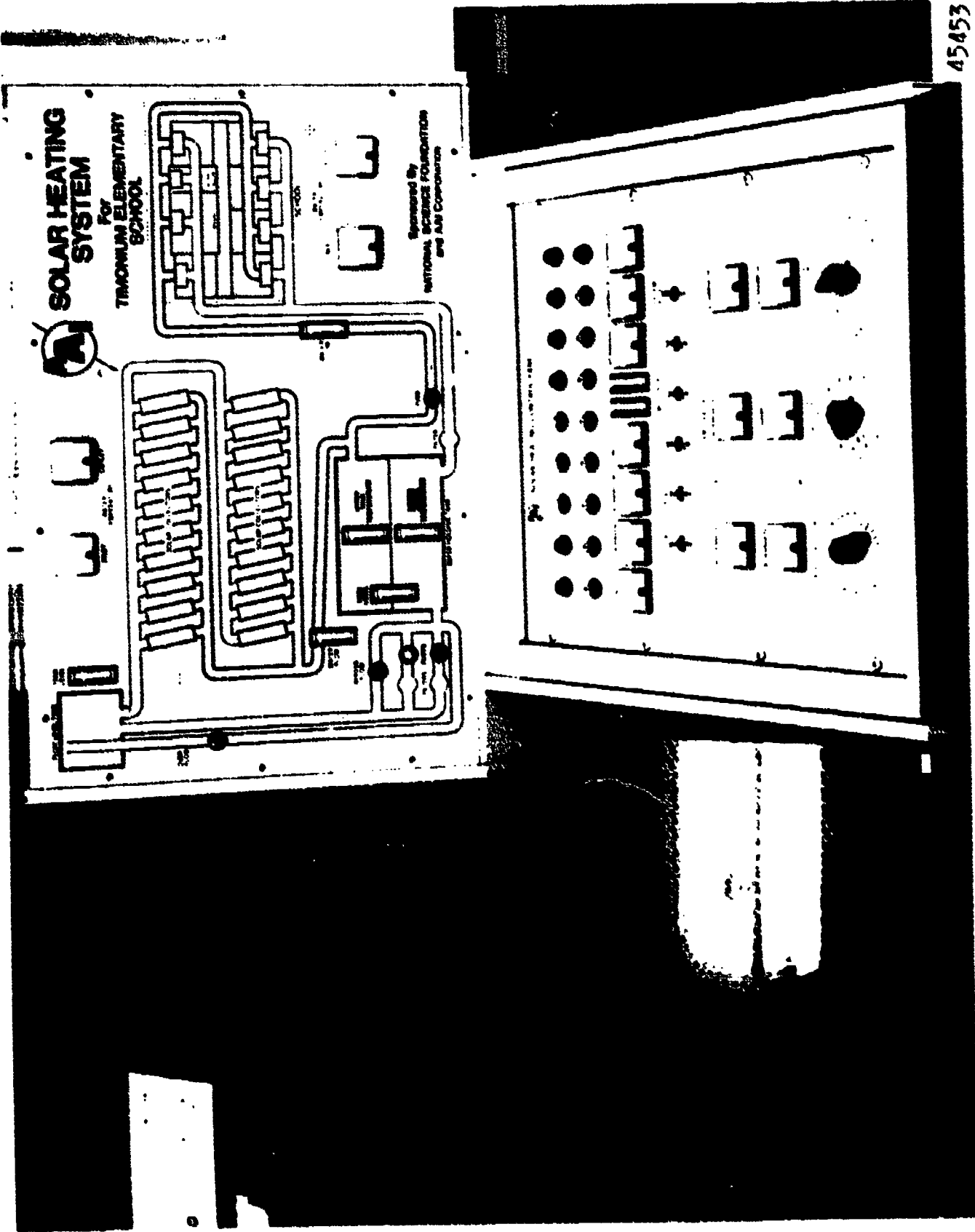

45453

Control Panel with Schematics

Figure 2-29

15704

SOLAR HEATING CONTROL PANEL

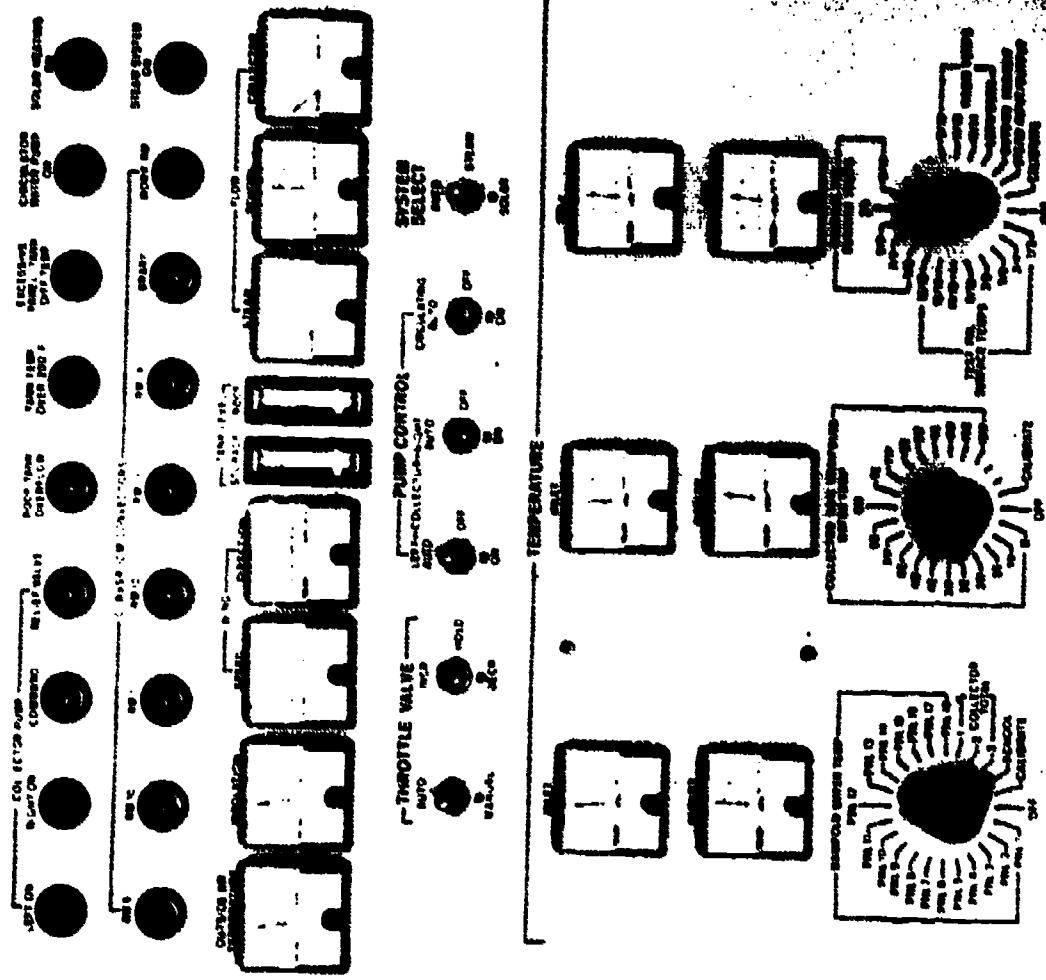

Close-Up View of Solar Heating Control Panel

Figure 2-30  
67

## Chart 2-1. Instrumentation for Timonium Elementary School

- A. Test data currently being continuously recorded on Leeds & Northrup Recorder**
1. Ambient temperature
  2. Collector water inlet temperature
  3. Collector water outlet temperature
  4. No. 3 collector surface temperature
  5. Heating system water inlet temperature
  6. Heating system water outlet temperature
  7. Heating system water flow (gal. per minute)
  8. Insolation
  9. Water volume of holding tank
  10. Water temperature at top of tank
  11. Water temperature at bottom of tank
  12. Inlet water temperature to No. 7 manifold which consists of 9 collectors in parallel
  13. Outlet water temperature to No. 7 manifold which consists of 9 collectors in parallel
- B. Present instrumentation currently being utilized in solar system and frequency of monitoring**
1. Insolation (continuous)
  2. Ambient temperature (continuous)
  3. Wind velocity (every half hour during periods of solar heat collection)
  4. Wind direction (same as above)
  5. Collector surface temperature
    - a. No. 3 (continuous)
    - b. Nos. 1, 2, 4, 5 & 6 (hourly during periods of solar heat collecting)

6. Collector water temperature in and out (continuously)
7. Fourteen collector manifolds (18 collections in parallel) (every hour during periods of solar heat collecting)
8. Collector water flow based on pump water output (pumps adjusted for desired water flow to collectors)
9. Steam temperature in and out (continuously)
10. Steam flow in pounds per hour (continuously)
11. School heating water temperature in and out (continuously)
12. School heat water flow in gallons per minute (continuously)
13. Level of water in holding tank (continuously)
14. Tank water temperature top and bottom (continuously)
15. Level of water in flow control tank (recorded when collector pumps are adjusted for desired flow to collectors)
16. Pressure gage for measuring air pressure from air compressor to thermostat (twice daily)
17. Deionizer indicator lamp for tank replenishment water supply (every hour during periods of water replenishment to tank)
- \* 18. Indicator lamps for collector pumps and heating system pumps
- \* 19. Indicator lamp for water overflow line to collectors
- \* 20. Indicator lamps for solar collection system, school heating system and command indication (indicates collector surface temperature with respect to tank water temperature is sufficient to effectively collect solar heat)
21. Tank level sight gage (twice daily)
22. Pressure gages for determining condition of water filters in system (daily)
23. Collector supply line throttle valve position indicator (visually checked when collector water supply pumps are adjusted for desired flow)
- \* 24. Indicator lamps for indicating opening and closing of throttle valve when the system automatic mode is being employed.

**\*Visual observation when operator is present.**

- 25. Direct reading electric watt/hour meter for collector pumps and unit heater's fan motors (daily)**
- 26. Fuel oil tank depth gage for determining fuel consumption (weekly)**

### **III. ANALYSIS OF OPERATION**

#### **A. Direct Operating Costs of Solar Heating System**

The direct operating cost for the system is the total cost of the electrical energy that is utilized in the collection of the solar heat, the supply and distribution of the heat to the school, and the operation and monitoring of the control system. Specifically, the electrical energy provides the motive, power for the operation of both the collector and school heating water pumps, the unit heater's circulating fans, the air compressor in the school heating control system, and the electrical circuits in the control and monitoring system.

The following graphs present the electrical consumption and costs for the operation of the various system elements during the period of 1 March 1974 to 15 May 1974.

The total electrical cost for the period was \$10.40.

'72

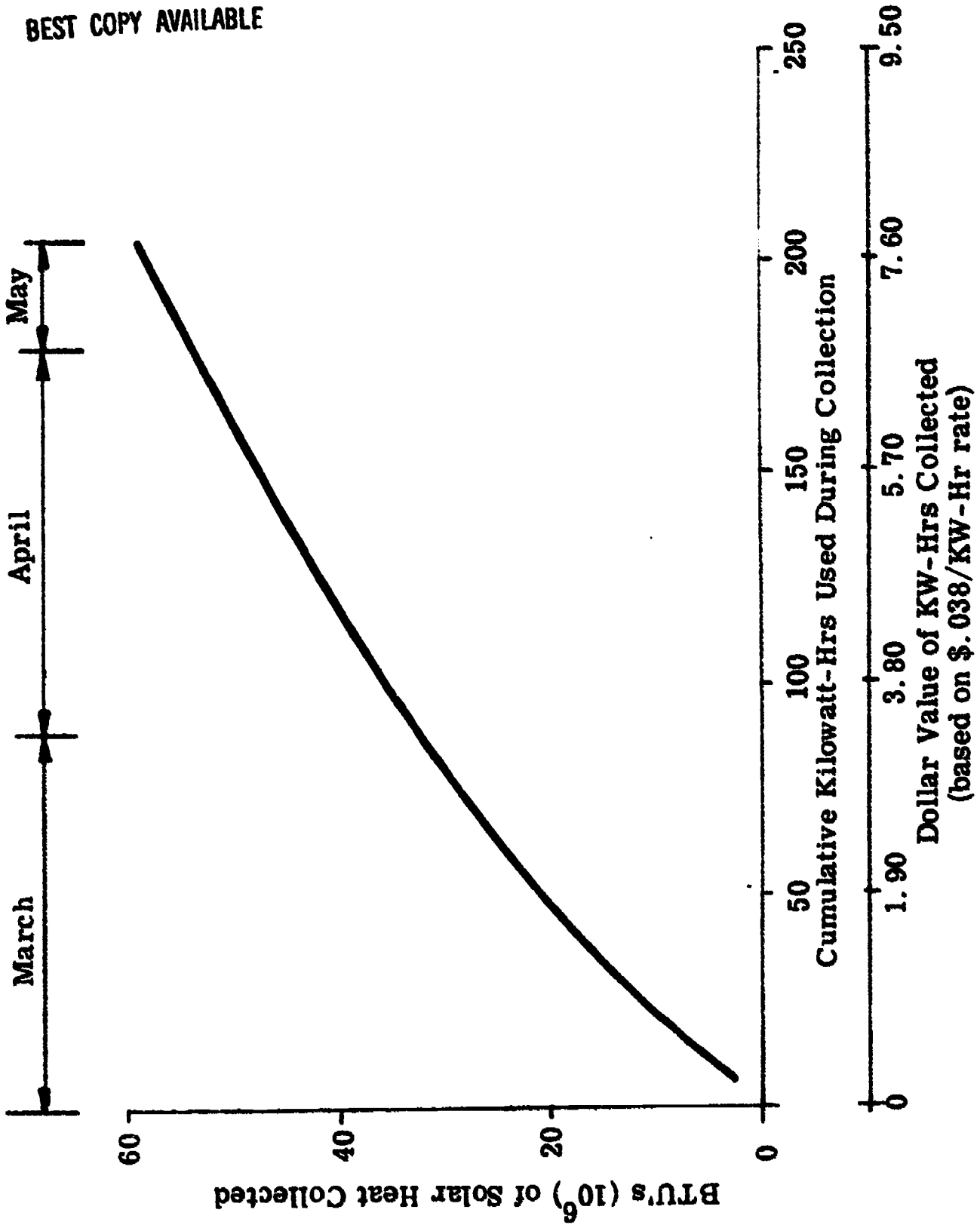
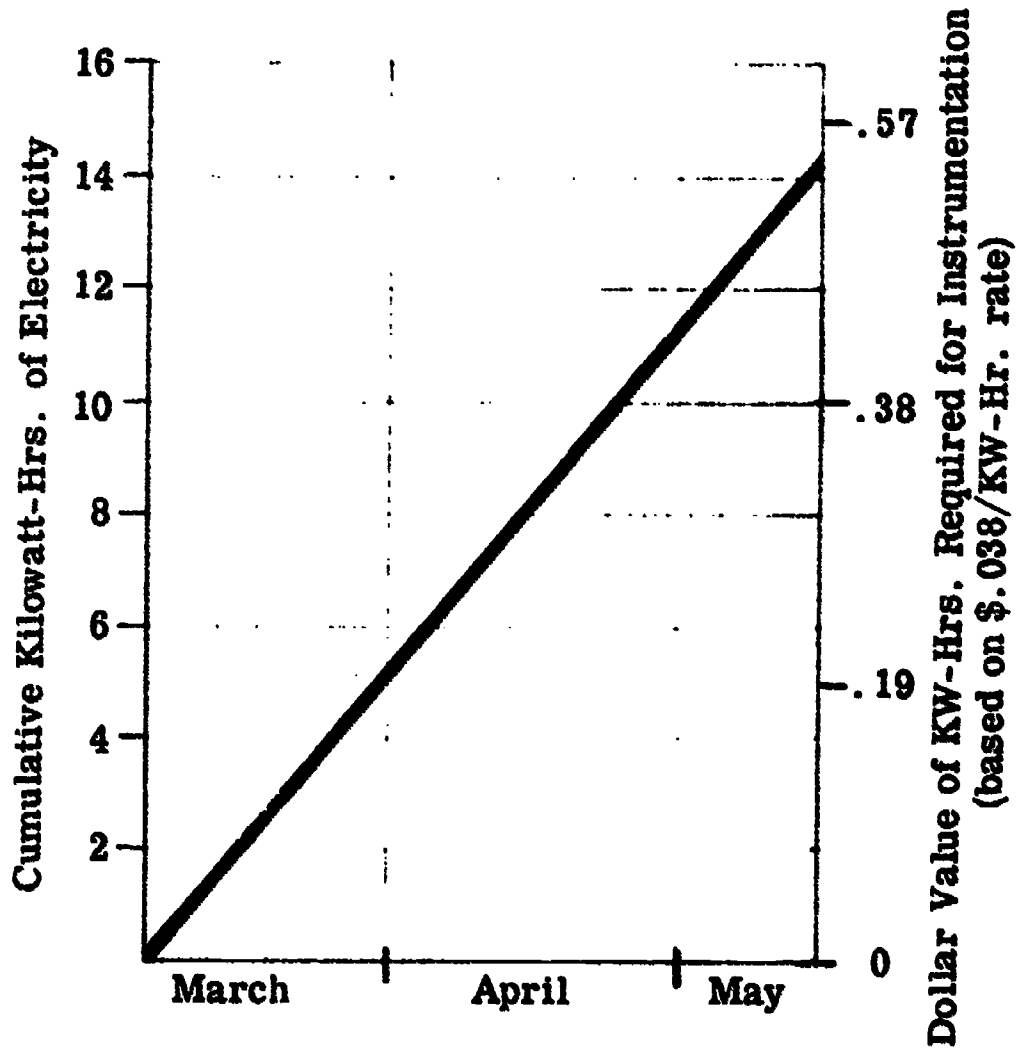

Figure 3-1



**KW-HR of Electricity Required  
For Instrumentation Operation**

**Figure 3-2**



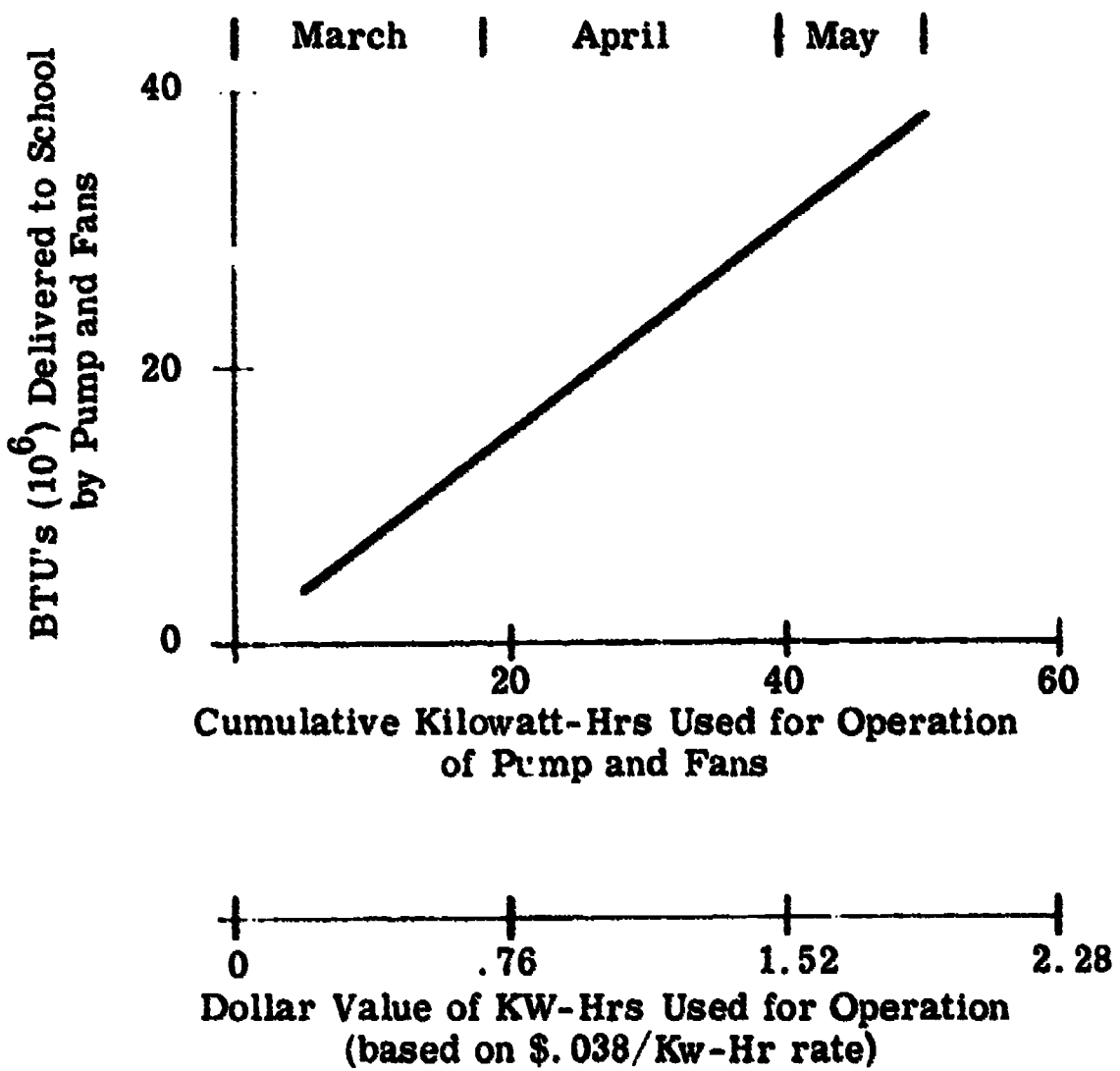

**Supply and Distribution Cost  
of Solar Energy for School Heating**

**Figure 3-3**

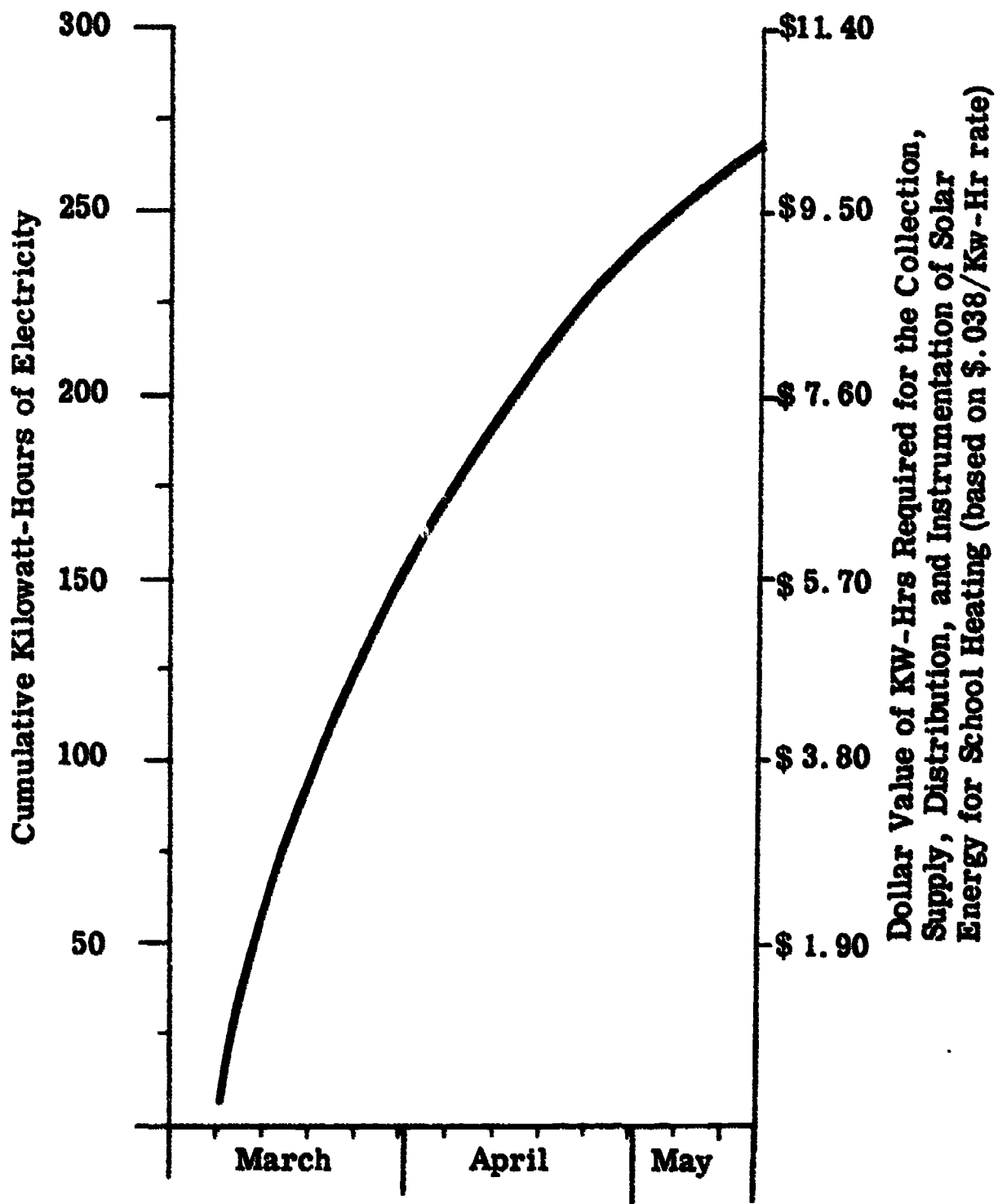

**Total System Operating Cost**

**Figure 3-4**

## **B. Fuel Savings**

The utilization of solar heating for the center wing portion of the Timonium School resulted in an overall fuel cost saving to the school for the period of 14 March 1974 to 15 May 1974. This cost savings was due to the Solar Heating System providing 91% of the center wing's heat requirement during this period.

From the school's fuel record the amount of fuel oil consumed by the heating plant was established. This was ratioed to the area heated and it can be shown that approximately 1200 gallons of fuel oil were saved by the use of solar heating for the center wing of the school.

From this information the graph in Figure 3-5 presents the accumulative fuel savings per month during the operation period of this system.

This amounts to a total saving of 1200 gallons of fuel oil.

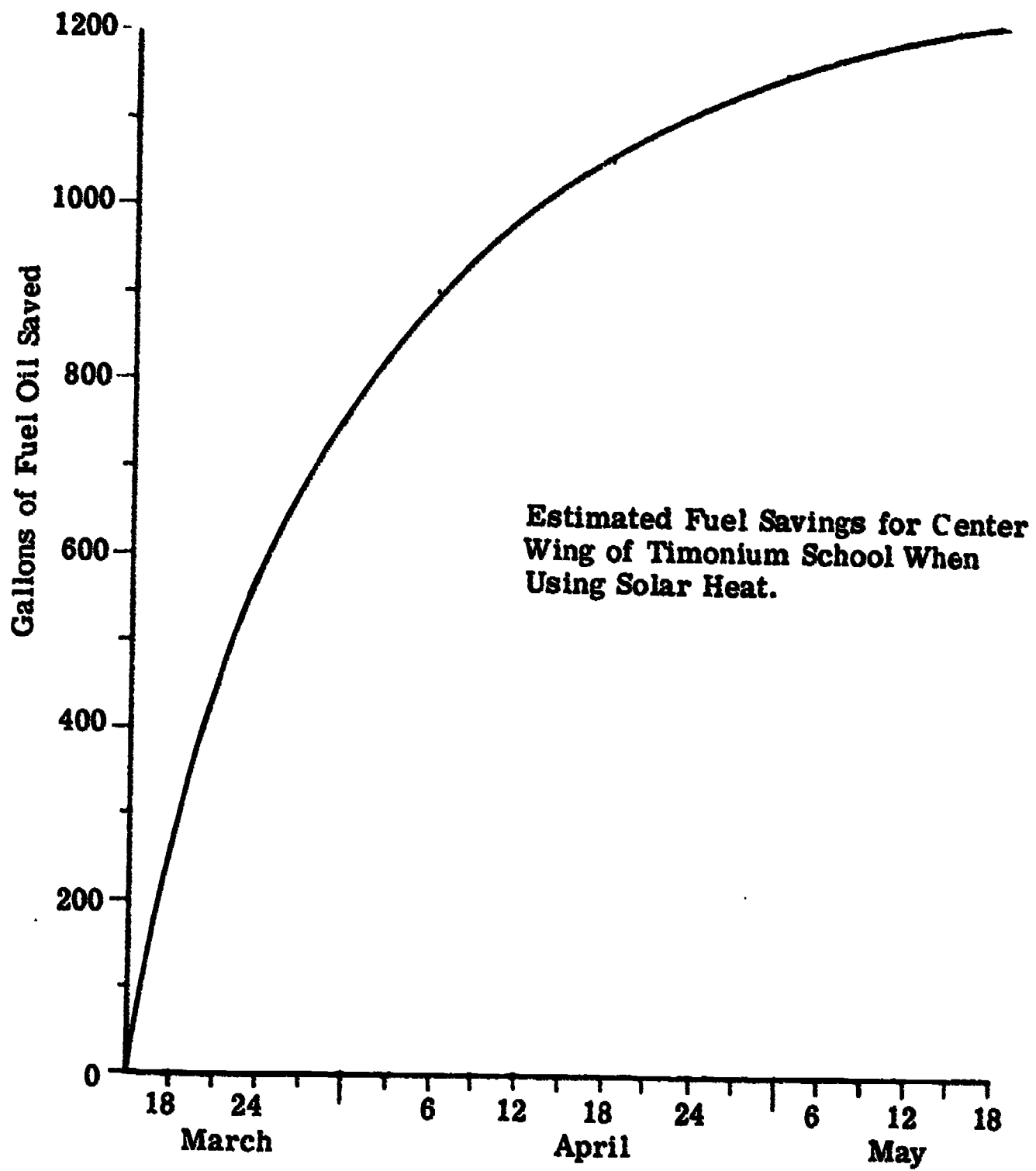

Figure 3-5

### **C. Maintenance Required**

**In general for this type of system, the necessity for maintenance essentially stems from the hostile environmental conditions to which the system is subjected and from the rigors and physical loading induced into the system components by actuations during the operating cycle. The necessary maintenance that was employed during this program to combat the above adverse conditions consisted of providing either preventative type maintenance or an operational type maintenance (repairs) to the system's components. Much of the repair work that is listed in Figure 3-6 is really not in the domain of maintenance but is the result of wringing out a new system. However, because of the short exposure period provided by this program, the identifying of these repair areas may be beneficial to future maintenance planning.**

| Item  | Qty.   | Reason for Maintenance           | Work Performed               | Required Frequency                     | Unit Cost   | Total Cost |
|---|--------|----------------------------------|------------------------------|--|-------------|------------|
| Filterite Particle Filter                     | 3      | Prevent pressure loss in system  | Replace 36 filter cartridges | * 2 Months                             | \$1.36 each | \$49.00    |
| Deionization of Replenishment water to system | 1 unit | Protect system against corrosion | Replenish 300 gal.           | As needed to replace evaporatin losses | \$.04/gal.  | \$12.00    |
| Pump strainer for motor driven throttle valve | 1      | Prevent pressure loss in system  | Cleaned                      | As needed                              | --          | --         |

**Preventative Maintenance Performed on Timonium Solar Heating System**

\* Required because system was not flushed before start-up.

| Item                           | Qty. | Reason for Maintenance           | Work Performed                          | Required Frequency                     | Maint. Hours | Labor Cost at \$12/Hr |
|--------------------------------|------|----------------------------------|---|--|--------------|-----------------------|
| Collector Pumps                | 2    | Mechanical failure               | Replaced pumps                          | **                                     | 2            | \$24.00               |
| Instrumentation                | -    | Electrical Component Malfunction | Replace defective components            | Would not be required in normal system | 8            | \$96.00               |
| Solenoid valve                 | 1    | Malfunction                      | Repaired valve                          | As needed                              | 2            | \$24.00               |
| Manifold/collector connections |      | Rubber hose split                | Hose replaced                           | As needed                              | 4            | \$48.00               |
| Collector panel                | 2    | Panels damaged by vandalism      | Repaired w/1 ft <sup>2</sup> tape patch | As needed                              | 1            | \$12.00               |

**Operational Maintenance Performed on Timonium Solar Heating System**

\*\* Pumps were defective and were replaced by vendor.

Figure 3-6

## D. Capital Equipment Costs

A chart showing a breakdown of the capital equipment costs for the Timonium School Solar Heating Installation is shown in Figure 3-7.

The cost figures shown include overhead and burdens as applicable to normal operations at AAI.

Also included is data which shows the estimated costs for these same items if the program was not conducted on an expedited basis. The engineering and the manufacturing costs were reduced 20% and procurement dollars were reduced 5%. These two factors reduced the total cost about 13%.

Figure 3-8 shows this data.

Further discussion of the major cost elements is as follows:

### Solar Collectors

The costs included in this category include the collector engineering, manufacture, and temporary tooling required for manufacture of the quantity for the installation. One hundred eighty (180) collectors with six spares were fabricated. The total cost for the collectors, on a non-expedited basis, is projected at \$106,450. Divided by 5200 Ft<sup>2</sup> of collector, the unit cost would be \$20.50 per Ft<sup>2</sup>. Without engineering, this cost would be reduced to \$16.70 per Ft<sup>2</sup>.

**Actual Capital Equipment Costs of  
AAI Solar Energy Proof-of-Concept Experiment  
(Expedited Program)**

| Major Category                                      | Engineering  |                | Manufacturing |                | Procurement Dollars | Total Dollars  |
|---|--------------|----------------|---------------|----------------|---------------------|----------------|
|   | Approx. Hrs. | Dollars        | Hours         | Dollars        |                     |                |
| 1. Collectors Including Temporary Tooling           | 1400         | 24,500         | 5000          | 67,000         | 35,000              | 126,500        |
| 2. Mounting Trusses - School Modifications - Screen | 1200         | 21,000         | 2800          | 37,520         | 27,500              | 86,020         |
| 3. Collector Plumbing - Pump House                  | 900          | 15,750         | 1400          | 18,760         | 22,500              | 57,010         |
| 4. Insulated Storage Tank                           | 600          | 10,500         | 1200          | 16,080         | 12,500              | 39,080         |
| 5. School Plumbing and Convectors                   | 400          | 7,000          | 200           | 2,680          | 60,000              | 69,680         |
| 6. Instrumentation                                  | 1000         | 17,500         | 1200          | 16,080         | 41,250              | 74,830         |
| 7. Installation                                     | 500          | 8,750          | 1000          | 13,400         | 31,250              | 53,400         |
| <b>Total</b>  | <b>6000</b>  | <b>105,000</b> | <b>12800</b>  | <b>171,520</b> | <b>230,000</b>      | <b>506,520</b> |

Figure 3-7



**Estimated Capital Equipment Costs  
Of AAI Solar Energy Proof-of-Concept Experiment  
(Costs reduced to show effect of a non-expedited program)**

| Major Cost Category                  | Engineering Reduced<br>20% for Non-<br>Expedited Program |               | Mfg. Reduced<br>20% for Non-<br>Expedited Program |                | Proc. Dollars  | Total Dollars  |
|--------------------------------------|--|---------------|---|----------------|----------------|----------------|
|                                      | Hours  | Dollars       | Hours   | Dollars        |                |                |
| 1. Collectors                        | 1120   | 19,600        | 4000  | 53,600         | 33,250         | 106,450        |
| 2. Mounting Trusses                  | 960  | 16,800        | 2240  | 30,016         | 26,125         | 72,941         |
| 3. Collector Plumbing                | 720  | 12,600        | 1120  | 15,008         | 21,375         | 48,983         |
| 4. Insulated Storage Tank            | 480  | 8,400         | 960   | 12,864         | 11,875         | 33,139         |
| 5. School Plumbing and<br>Convectors | 320  | 5,600         | 160   | 2,144          | 57,000         | 64,744         |
| 6. Instrumentation                   | 800  | 14,000        | 960   | 12,864         | 39,188         | 66,052         |
| 7. Installation                      | 400  | 7,000         | 800   | 10,720         | 29,687         | 47,407         |
| <b>Total</b>                         | <b>4800</b>  | <b>84,000</b> | <b>10,240</b>                                     | <b>137,216</b> | <b>218,500</b> | <b>439,716</b> |

Figure 3-8

### Mounting Trusses - School Modifications - Protective Screen

The costs incurred in this category were attributed to the addition of the Solar Heating System to a school already built. It is estimated that only 10% of this cost would be incurred if the Solar Heating System would have been built into a new school at the present time. This 10% would be for protective shielding.

### Collector Plumbing - Pump House

The costs for the collector plumbing include a separate pump house which would not be required in a new school where Solar Heating would be part of the main heating plant. In addition, extra flow meters and valves were installed for obtaining operational data. In a new school, it is estimated that this cost would be about \$1.50 per Ft<sup>2</sup> of collector area.

### Insulated Storage Tank

The costs for the tank design and manufacture is included in this category. In addition, the insulation and concrete pad are included. On a non-expedited program, the capital cost of the tank was \$2.10 per gallon of water storage capacity.

The storage tank cost could be reduced to about \$0.60 per gallon by the use of a prefabricated, insulated tank procured from an established tank fabricator.

## School Plumbing and Convectors

The labor for the installation of the school plumbing and convectors was performed by a subcontractor. Therefore, the labor costs shown for this category are small and the subcontract costs are high. Since the Timonium Elementary School had a steam system, a completely new hot water system was installed. In a new school with a hot water system, the cost for this category would be completely eliminated.

If an existing school with hot water heat were converted to Solar Heat, the cost for this cost element would be about 5% of those experienced.

## Instrumentation

The instrumentation costs incurred were primarily for use in obtaining experimental data. In a new or converted school, the instrumentation costs would be about 2% of those experienced at Timonium Elementary School.

## Installation

The installation costs were somewhat high at Timonium Elementary School because the work was done on the wing during a period when classes were in session. It is estimated that the costs would be about 90% of those experienced if the school wing were not in use.

On a new school, we estimate the installation costs would be about 20% of those at Timonium Elementary School. Instrumentation would not have to be installed and walls would not have to be pierced for pipes, for example.

## Summary

Figure 3-9 shows a Solar Heating Capital Cost comparison of the Timonium Elementary School with a typical school with a hot water heating system and with a new school with Solar Heating designed into the original plan.

This study shows that it is much more economical to build the system into a new school rather than apply it to an existing structure. The new school costs drop 50% over the existing school cost.

Collector costs are expected to drop considerably in the future as mass production tooling becomes available. Assuming the collector cost drops from \$16.70 per Ft<sup>2</sup> to one-third of that value or \$5.40 per Ft<sup>2</sup>, the system cost would then drop to \$13.43 per Ft<sup>2</sup> of collector area.

## School Capital Cost Comparisons & Projections

- Conditions:
1. No escalation in price
  2. Non-expedited programs
  3. All schools same size in same climate with same size solar system

| Cost Element   | Timonium Elem. School - Actual Non-expedited | Typ. School w/Existing Hot Water Heat (Not an Experiment) | New School With Solar Heating Designed into Original Plan |
|--|--|---|---|
| 1. Collectors  | \$106,450                                    | \$86,850<br>(Engineering not required)                    | \$86,850<br>(Engineering not required)                    |
| 2. Mounting Trusses  | 72,941                                       | \$72,941  | \$ 7,294  |
| 3. Collector Plumbing  | 48,983                                       | 7,800*  | 7,800*  |
| 4. Insulated Storage Tank  | 33,139                                       | \$ 9,000**  | 9,000**   |
| 5. School Plumbing & Convectors  | 64,744                                       | 3,230   | Part of basic heating system                              |
| 6. Instrumentation   | 66,052                                       | 1,320   | 1,320   |
| 7. Installation  | 47,407                                       | 42,700  | 9,480   |
| <b>Total System Cost</b>   | <b>\$439,716</b>                             | <b>\$223,841</b>  | <b>\$121,744</b>  |
| <b>System Cost/Ft<sup>2</sup> of Collector (5200 Ft<sup>2</sup>)</b>   | <b>\$ 84.56</b>                              | <b>\$ 43.05</b>   | <b>\$ 23.41</b>   |
| If the collector cost were reduced from \$16.70/Ft <sup>2</sup> to \$5.40/Ft <sup>2</sup> (one-third), the system cost/Ft <sup>2</sup> of collector would be as follows: |  |   |   |
| <b>System Cost/Ft<sup>2</sup> of Collector (5200 Ft<sup>2</sup>)</b>   | <b>--</b>                                    | <b>\$ 31.74</b>   | <b>\$ 12.11</b>   |

\* Based upon plumbing costs of \$1.50/Ft<sup>2</sup> of collector area.

\*\* Based upon the use of a prefabricated, insulated tank procured from an established tank fabricator.

Figure 3 9

## **E. Solar Collecting Performance and Efficiency**

### **1. Solar Collecting Performance**

The solar collecting performance of the Timonium Solar System for its period of operation is shown in Figure 3-10. This graph essentially portrays the overall solar heat collecting capability of the system by comparing the number of BTU's collected on a per day basis with the solar heat collection constraints of collector inlet temperature, solar insolation, and ambient temperature.

The chart in Figure 3-11 presents a monthly and total summary of the BTU's collected, the number of collection days, the number of inclement weather days and the total number of operating days for this program.

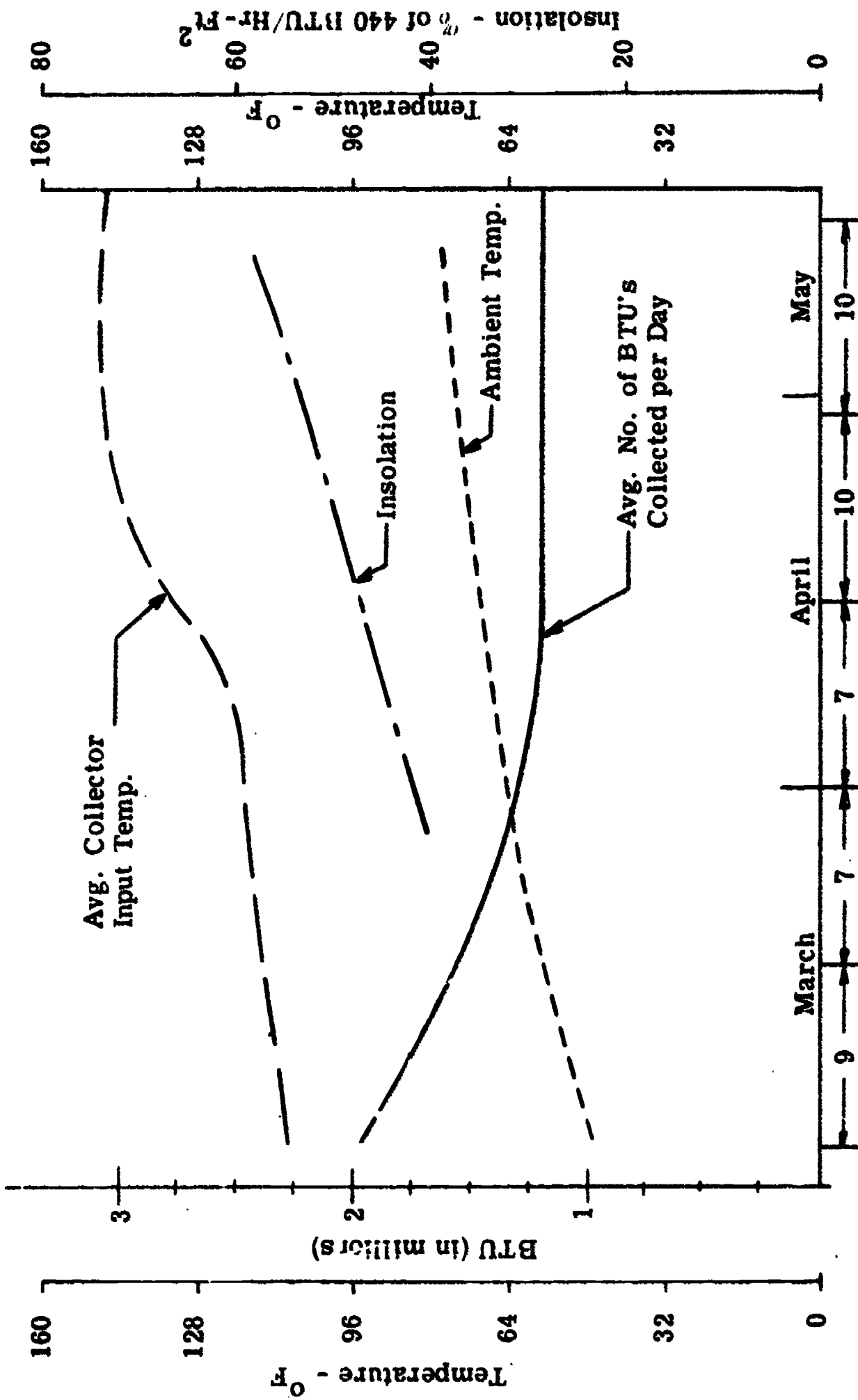

Number of Days Collected per 2-Week Period

Semi-Monthly Trend of Solar Collection Performance

Figure 3-10

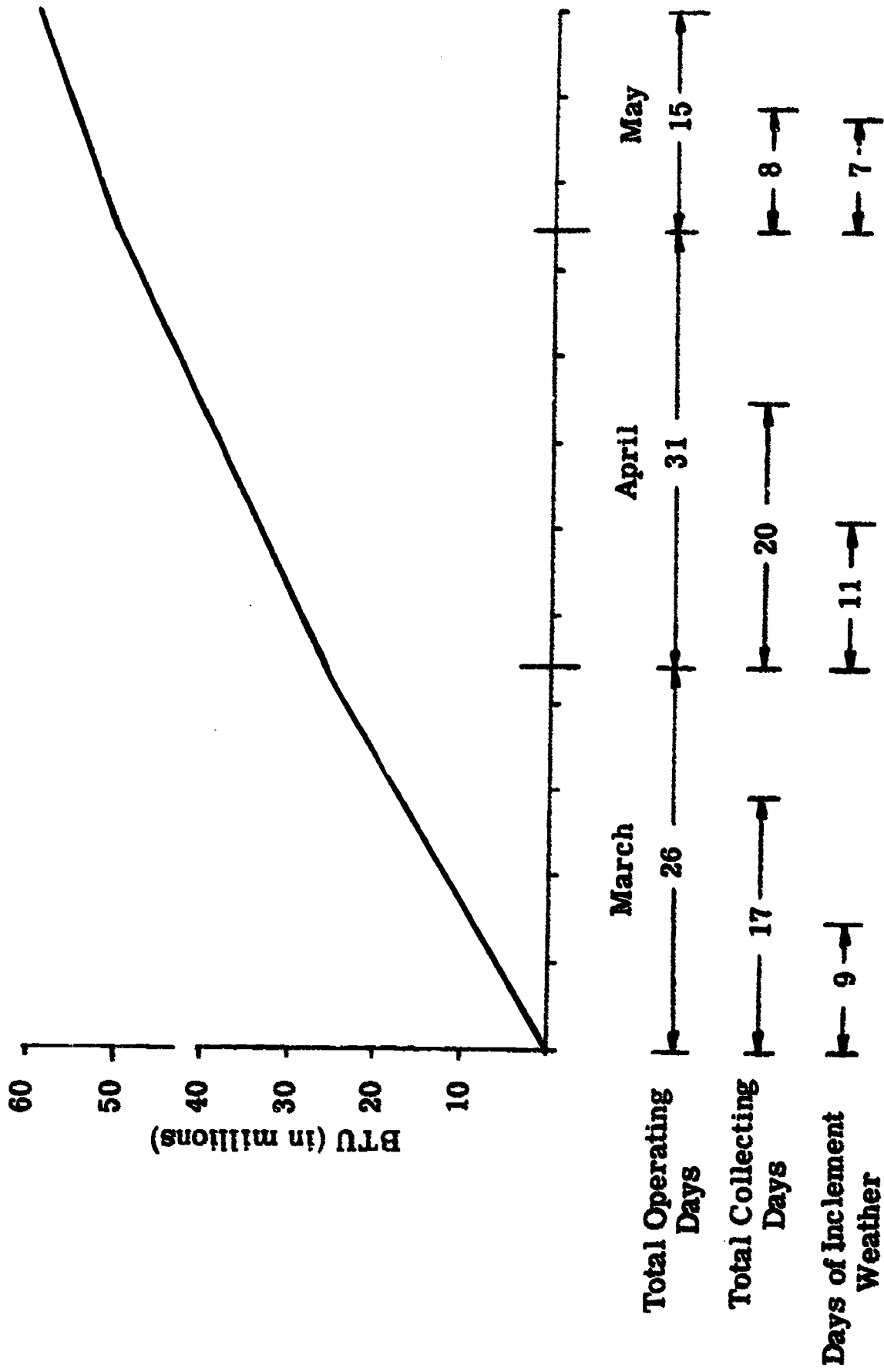

Monthly & Total Summary of Solar Heat Collection Performance

Figure 3-11





## 2. Solar Collecting Efficiency

The intent of the following graph of solar collecting efficiency is to illustrate the maximum solar heat collecting capability of the Timonium Solar Heating System. The 29 April 1974 day was essentially an ideal collecting day in that the climatic conditions and solar insolation were conducive to effective solar heat collection. To fully exploit these ideal collecting conditions, the system was operated in the manual mode which permitted fine tuning of the water flow to optimize the heat transfer at the collectors. Due to the remote location of the temperature measuring instruments, the efficiencies illustrated in the graph are not the absolute efficiency of the collector array but are those representative of the overall system.

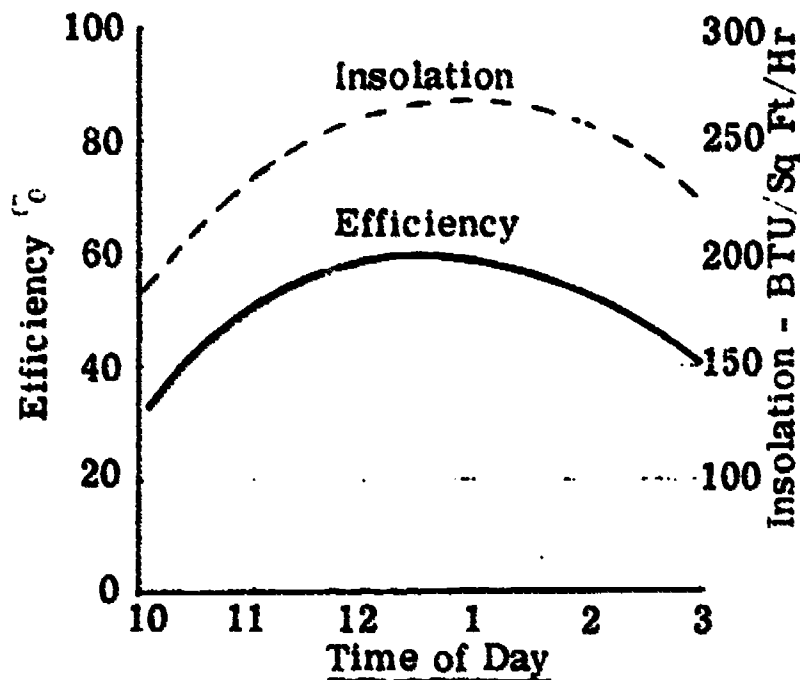

A. M. Inlet Water 140<sup>o</sup>F  
P. M. Inlet Water 147<sup>o</sup>F  
Outlet @ 156<sup>o</sup>F Avg.  
Temp. Ambient 70<sup>o</sup>F Avg.  
April 29, 1974 - No wind  
Clear

Based on this one day's data, the curve below was plotted. It shows how the collector efficiency varies from 32% to 61% with a varying insolation and temperature ratio.

Timonium Elementary School  
Data Collected April 27, 1974

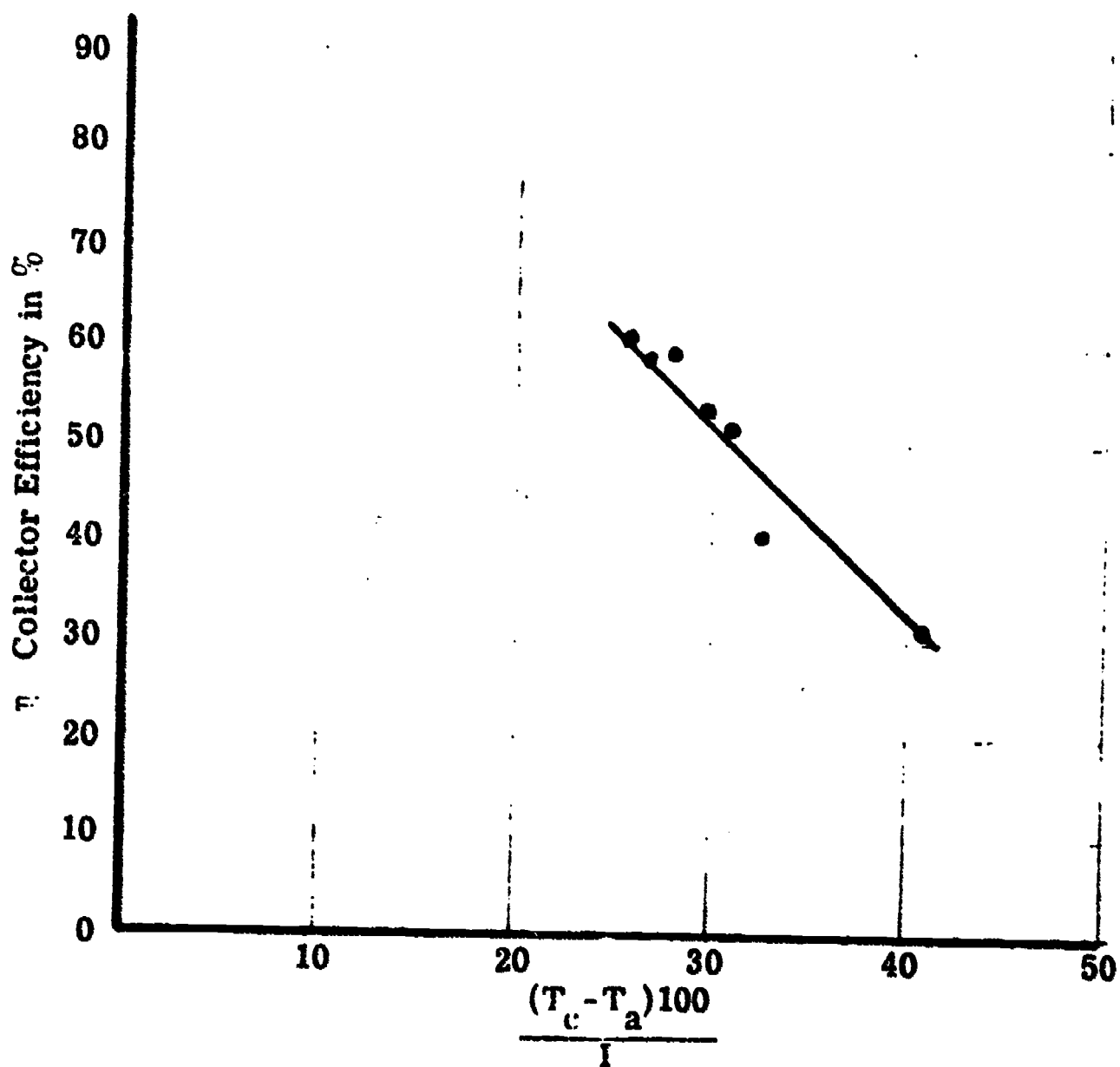

## **F. Typical Day's Operation (22 March 1974)**

Figure 3-12 depicts the daily operational performance with respect to environmental conditions of the solar heating system. This particular day was selected because the overall system had been sufficiently adjusted and tuned for efficient automatic operation and the climatic conditions were such that both school heating and solar collecting could be effectively employed. For this day's operation the graph summarizes the school's heating load, the quantity of solar heat collected and the effect of heat input and output on the holding tank's school heating capability.

It can be seen from the graph, that the heating potential of the tank (available BTU's for school heating) was approximately 3,000,000 BTU's at the start of the day. During the course of the day, the tank provided approximately 970,000 BTU's in meeting the school's heating demand and, including the system's piping circuits, lost through radiation an additional 120,000 BTU's. The collection of solar heat commenced at 10:30 a. m. and during the 7-hour operating period collected and supplied to the tank a total of 2,000,000 BTU's. Since the BTU's collected and supplied to the tank exceeded the total tank BTU loss by 910,000 the tank's heating potential was increased to 3,910,000 BTU at the completion of the day's operation.

# TYPICAL DAY'S OPERATION OF THE TIMONIUM SOLAR HEATING SYSTEM

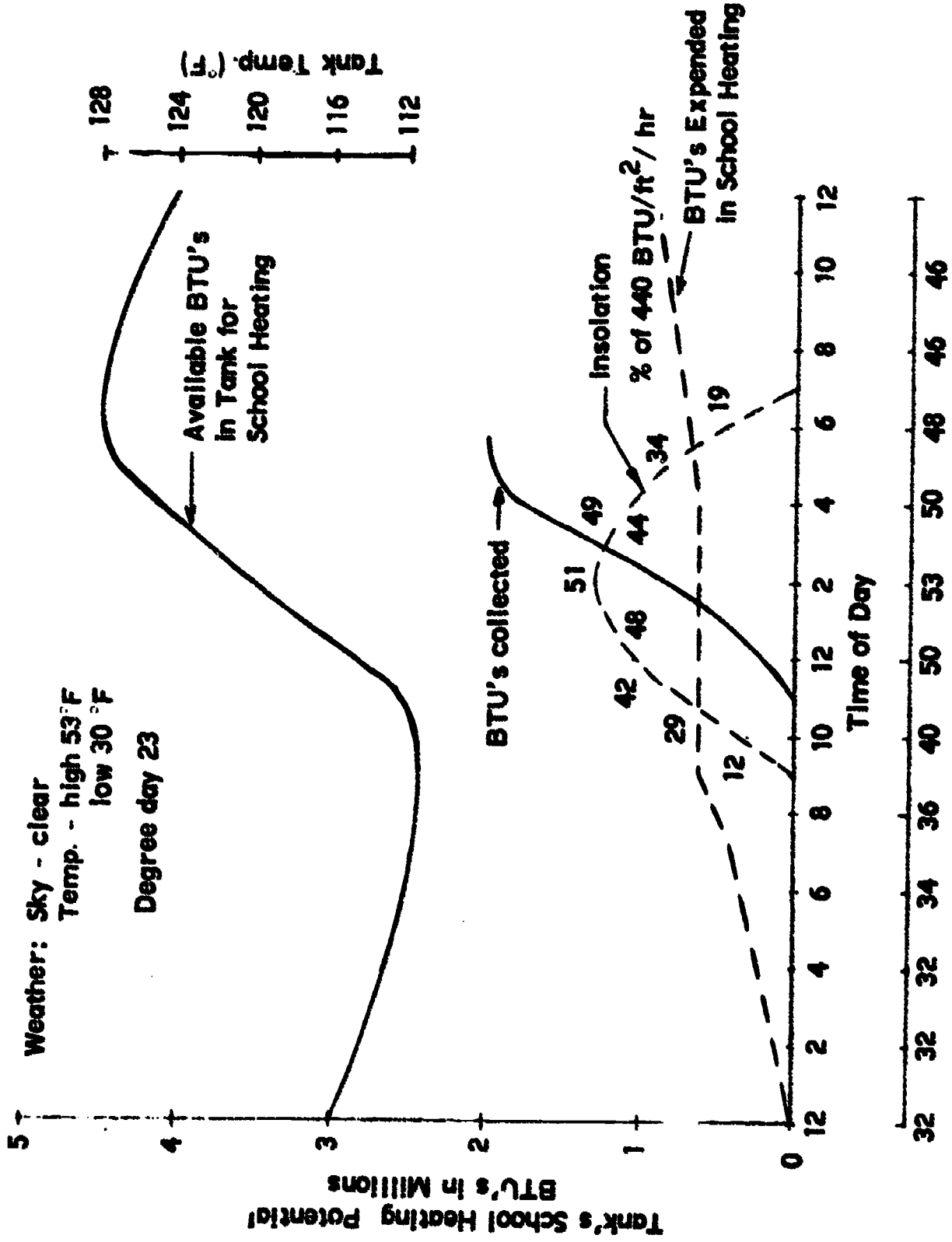
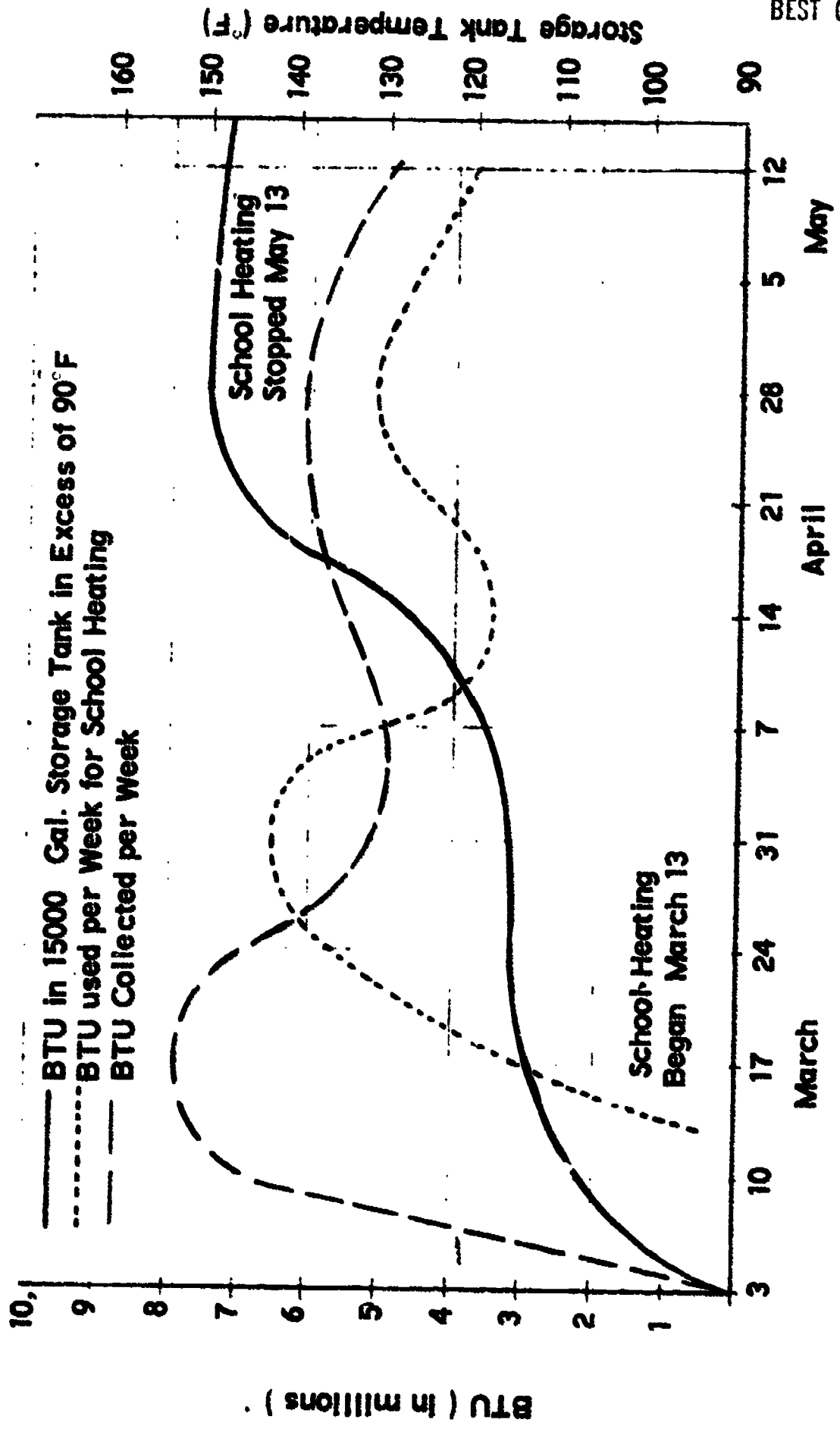

Figure 3-12

## **G. Heat Input and Output Summary**

The intent of the Heat Input and Output Summary is to portray in a monthly sequential manner the overall system performance of the Timonium Solar Heating System. The graph shown in Figure 3-13 chronologically presents an operating history of the BTU's collected, the BTU's expended in school heating and the school heating potential of the holding tank for the operational period of the solar system. However, to better illustrate the overall heat input/output performance of the system, Figure 3-14 graphically presents on a monthly basis, the average number of BTU's collected per day with respect to the school's average heating demand per day. Finally, the chart shown in Figure 3-15 presents on a monthly basis the accumulative totals of BTU's collected, BTU's expended in school heating, BTU's lost in tank and piping radiation, and BTU's stored in tank.

**OPERATIONAL PERFORMANCE OF THE TIMONIUM SOLAR HEATING SYSTEM  
FOR THE PERIOD OF MARCH 1974 TO 15 MAY 1974**



BEST COPY AVAILABLE

Figure 3-13



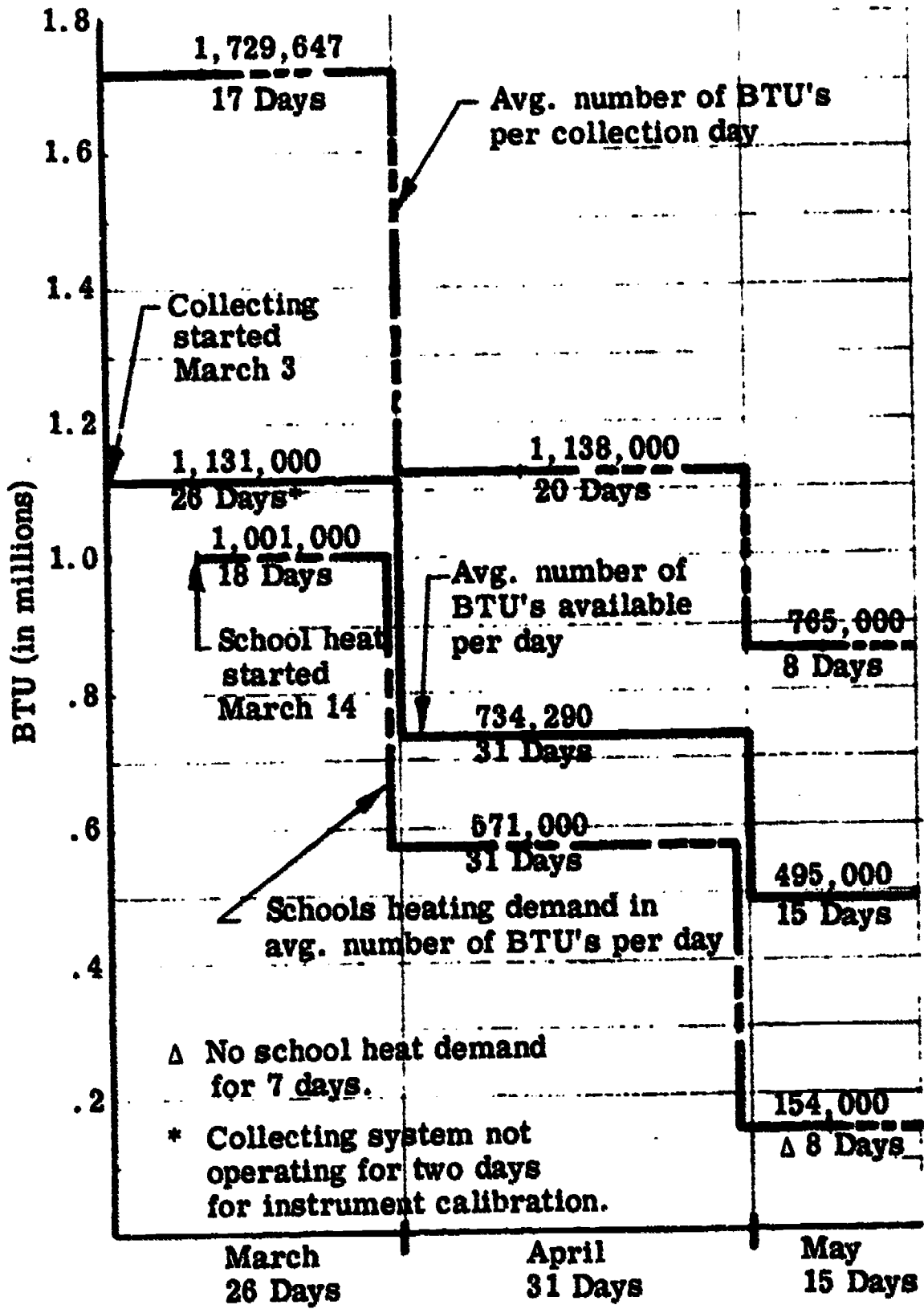

Average Number of BTU's Collected, Available, and Expended Per Day

Figure 3-14

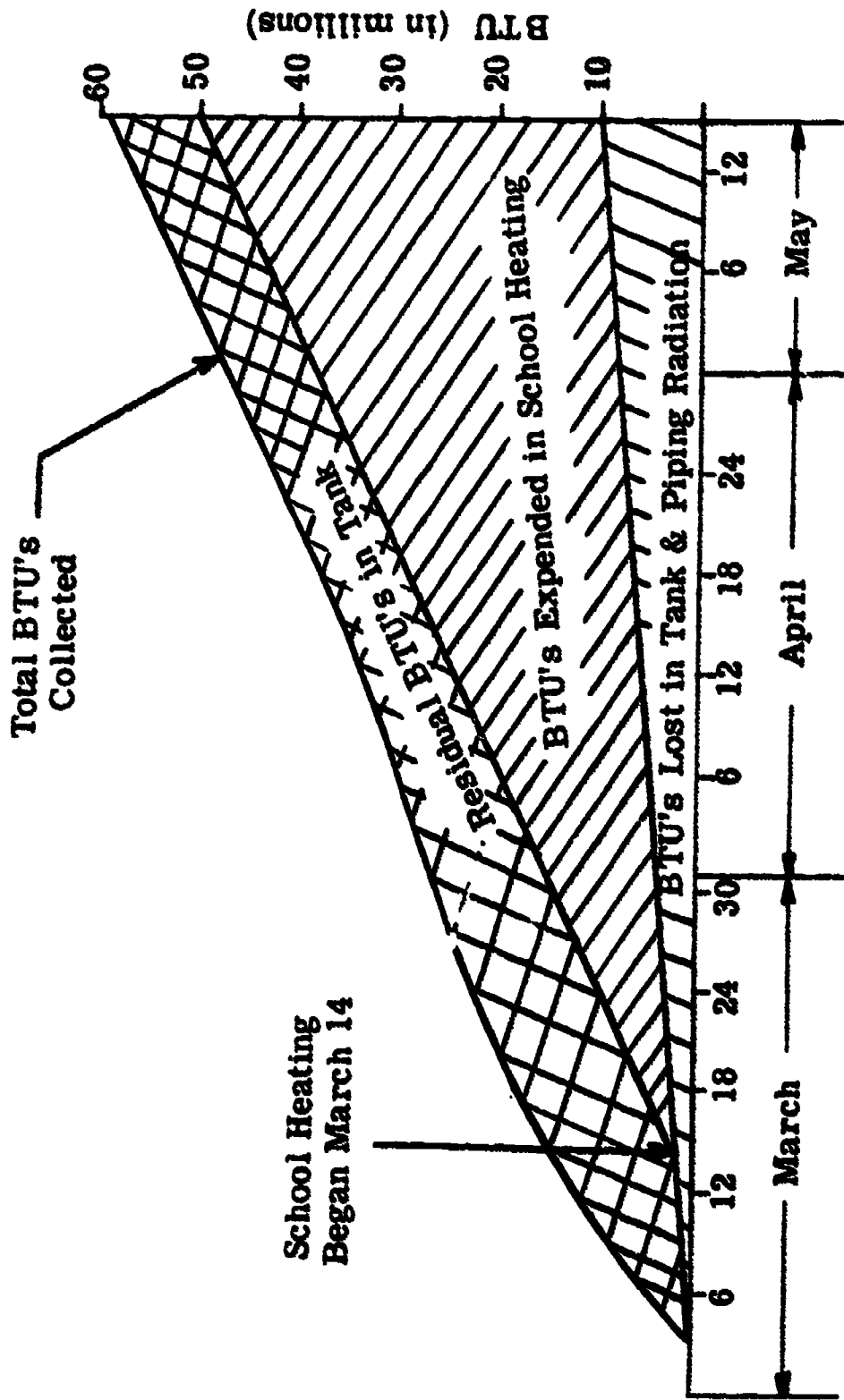

Total System Heat Input and Output  
During the Operational Period of the System

Figure 3-15



## **IV. RECOMMENDATIONS AND CONCLUSIONS**

### **A. Recommendations for Modifications to the System to Improve Performance or producibility in Order to Permit Widespread Applications of Solar Heating to School Buildings**

After only 2-1/2 months of heating system operation, it is too early to make large-scale recommendations for modifications. However, the following detail changes are suggested modifications to the present system.

#### **o Improved System Performance**

##### **Solar Heat Collection Efficiency**

- 1. Improve collector efficiency using methods such as selective coatings and three cover plates.**
- 2. Study holding tank temperature stratification problem in order to provide low temperature water to collectors.**
- 3. Use of reflectors for increased summer performance.**

##### **Reduce Heat Radiation Loss**

- 1. Increased insulation for pipes.**
- 2. Install holding tank in heated building to reduce the temperature gradient between tank and tank environment.**
- 3. Install all collector water supply and return lines and manifolds in the building to reduce the temperature gradient between piping and its environment.**

#### **o Improved Producibility**

- 1. Utilize standard steel or concrete tank for water storage.**
- 2. Simplify and reduce plumbing in the pumping station as follows:**

- a. Use threaded pipe connections rather than flanges except at the interfaces of the plumbing modules.
- b. Utilize one pump and associated components in collector pumping station rather than the dual set-up being currently used.

## B. Conclusions as to the Generalizability of the Results Obtained

1. Based on only 2-1/2 months of operation, only a small portion of the results obtained are generalizable at this time. These are the efficiencies, heat losses, heat requirements of schools per degree day, etc.

2. The cost studies of the capital investment for the system when projected for additional retrofit installations and for new school construction indicate the following:

### a. Retrofitting Schools for Solar Heating

By 1985 the retrofitting of schools in Maryland and farther north will be economically feasible. This will be made possible by the increasing cost of fossil fuels.

For areas of the southwest and south, the additional Btu's available from increased insolation will make retrofit more feasible in the current timeframe.

### b. New School Solar Heating

If the cost of fuel oil remained constant, a total installation cost per square foot on new construction would have to be below \$5.00/Ft. <sup>2</sup> for an amortization of 25 years at low interest.

If the cost of fuel doubled in 10 years, then the price per square foot could double to \$10.00/Ft. <sup>2</sup> for total installation now.

Present indications are that the system installed on new schools in 1975 would cost from \$9.00 to \$13.00 per square foot.

**APPENDIX A**

**DRAWINGS**

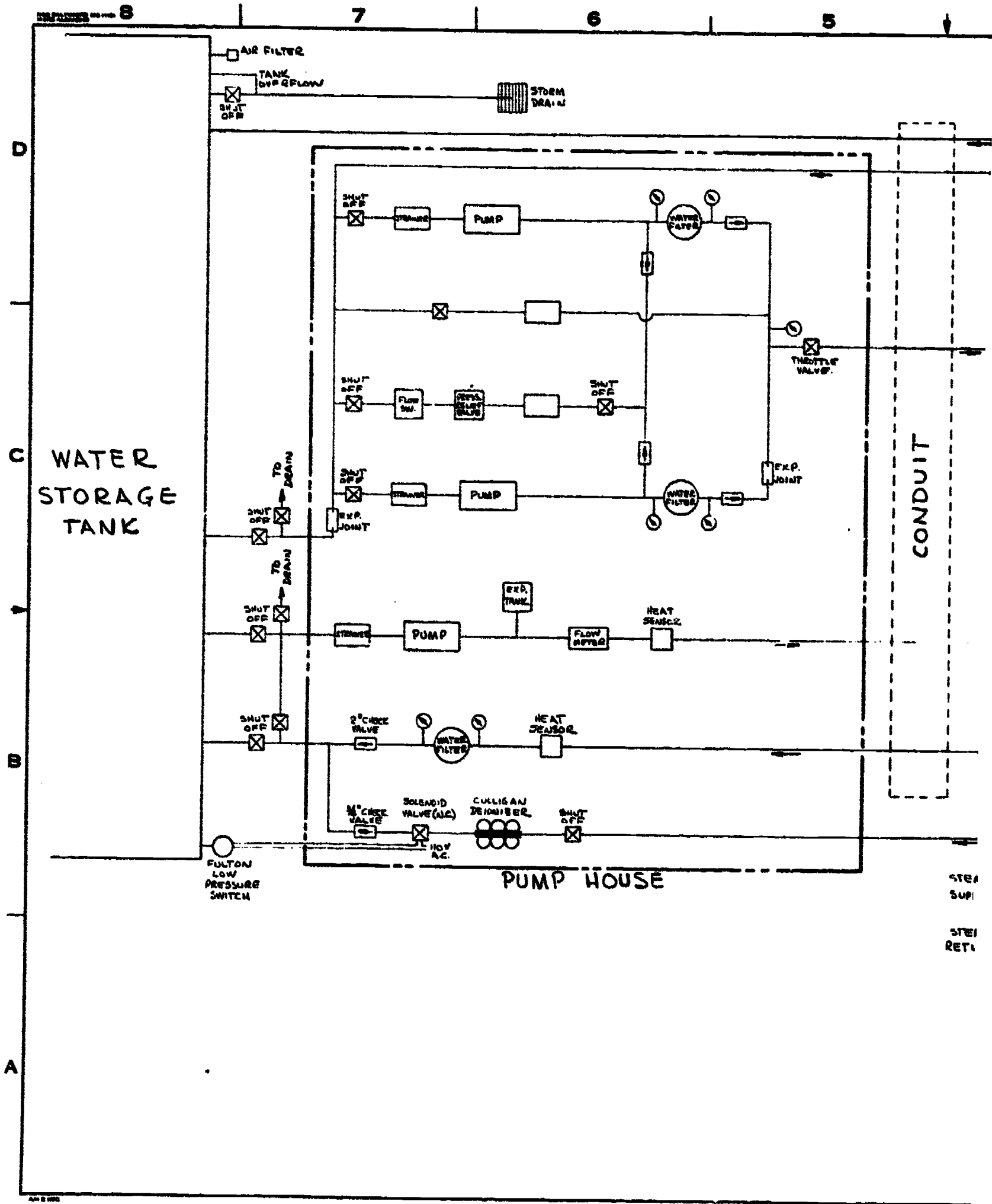

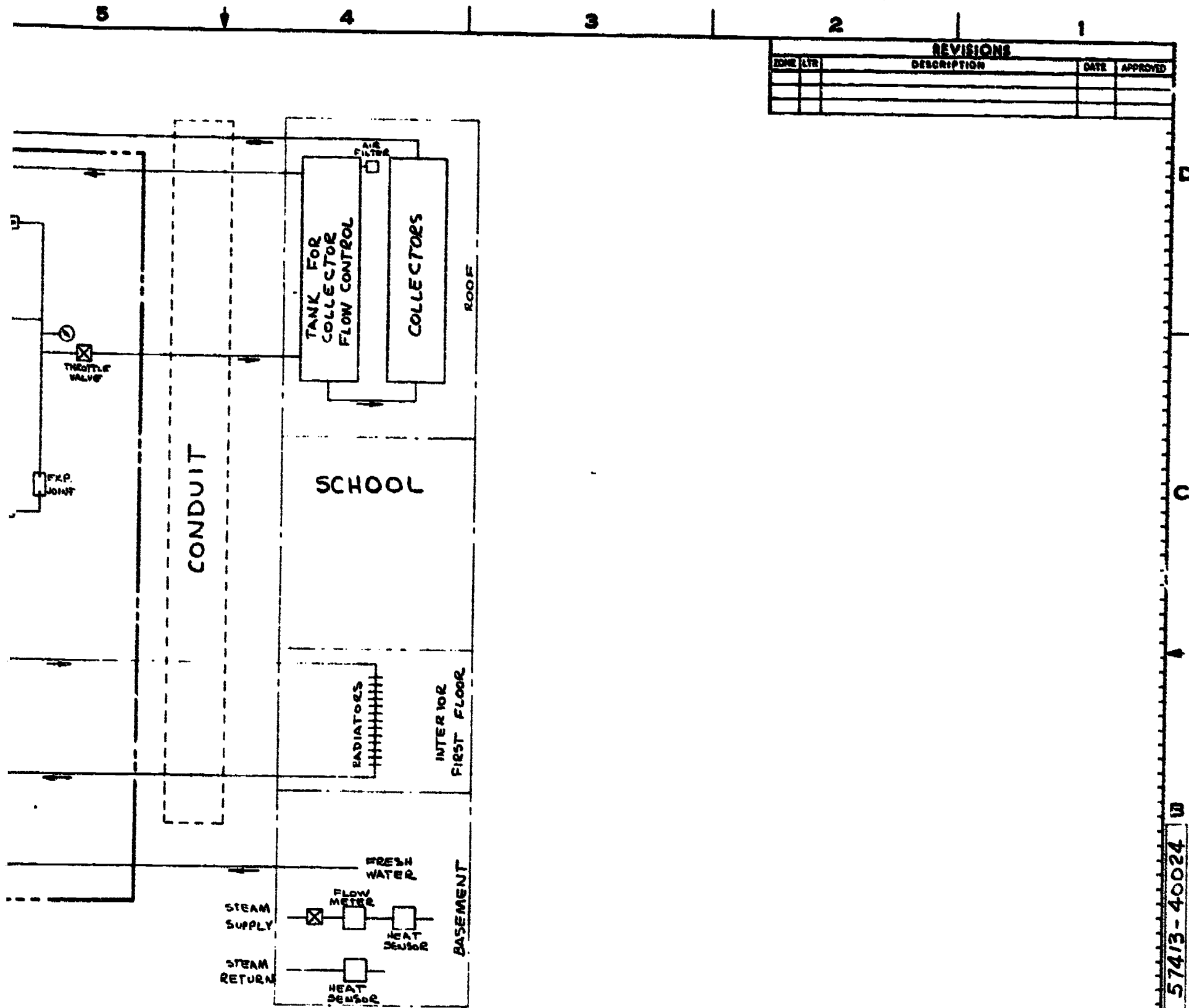

| REVISIONS |     |             |      |          |
|-----------|-----|-------------|------|----------|
| ZONE      | LTR | DESCRIPTION | DATE | APPROVED |
|           |     |             |      |          |
|           |     |             |      |          |
|           |     |             |      |          |

57413-40024 10

| ITEM NO.   | QTY REQ  | CODE IDENT     | PART NUMBER                             | SPECIFICATION NO. | NOMENCLATURE |
|--|----------|----------------|---|-------------------|--------------|
| PARTS LIST   |          |                |   |                   |              |
| REF SCALE 1" = 8'  |          |                |   |                   |              |
| UNLESS OTHERWISE SPECIFIED<br>DIMENSIONS ARE IN INCHES<br>AFTER PLATING<br>TOLERANCE |          |                | 3492<br>CONTRACT NO.                    |                   |              |
| ANGLES   |          |                | BALTIMORE, MD.                          |                   |              |
| DECIMAL  |          |                | DRAWN BY: <i>[Signature]</i>            |                   |              |
| 2 PLACE  |          |                | CHECKED BY: <i>[Signature]</i>          |                   |              |
| 3 PLACE  |          |                | DESIGN BY: <i>[Signature]</i>           |                   |              |
| MATERIAL:  |          |                | ENGINEERING PROJECT: <i>[Signature]</i> |                   |              |
| NEXT ASSY  | USE J ON | SIZE D         |   |                   |              |
| APPLICATION  |          | DESIGN ACT APP |   | CODE IDENT NO.    | 57413-40024  |
| APPROVAL   | DATE     | SCALE          | SHEET                                   |                   | OF           |



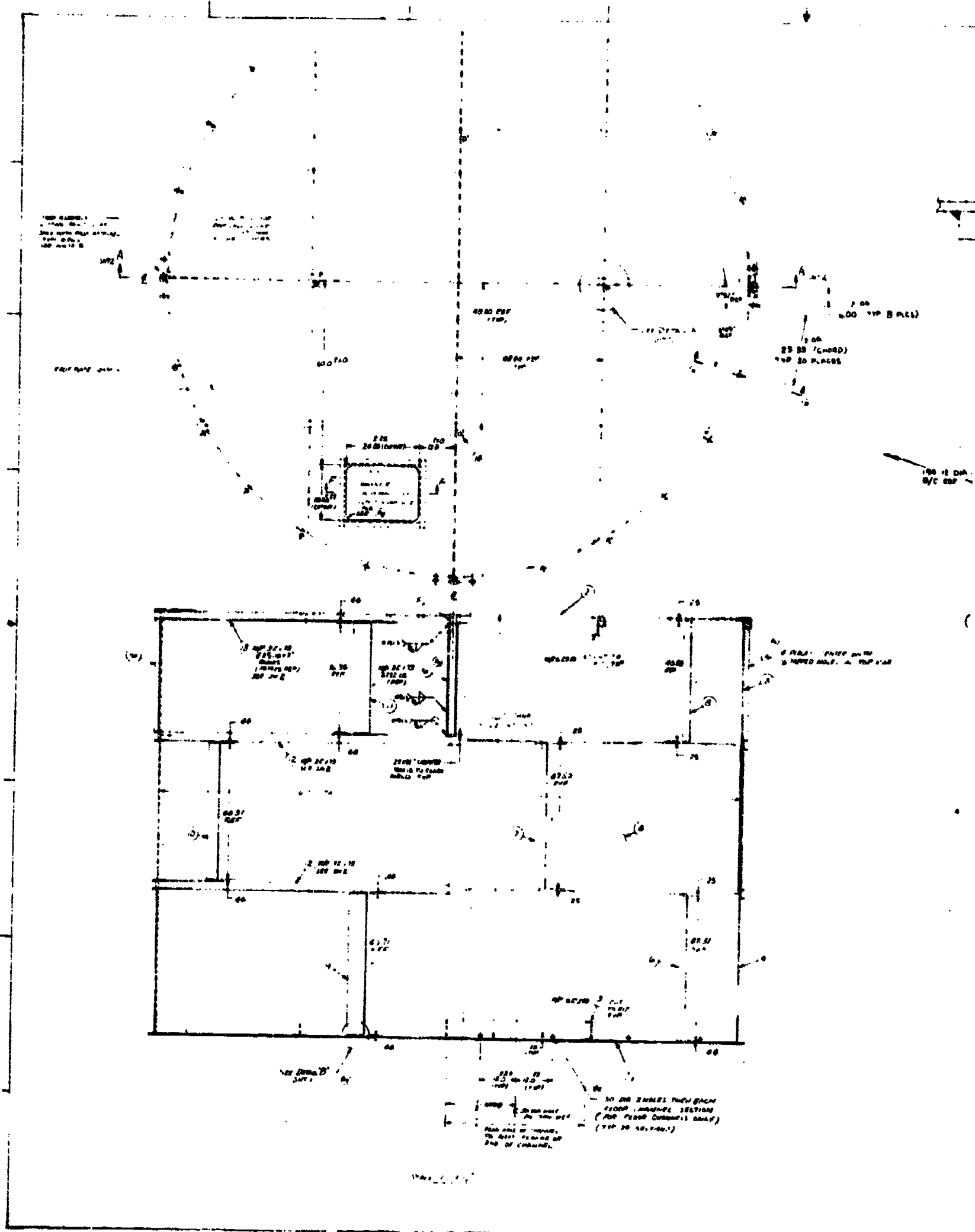

| REVISION | DESCRIPTION            | DATE    |
|----------|------------------------|---------|
| 1        | Issue and 1st revision | 10/1/58 |
| 2        | Issue and 2nd revision | 10/1/58 |
| 3        | Issue and 3rd revision | 10/1/58 |

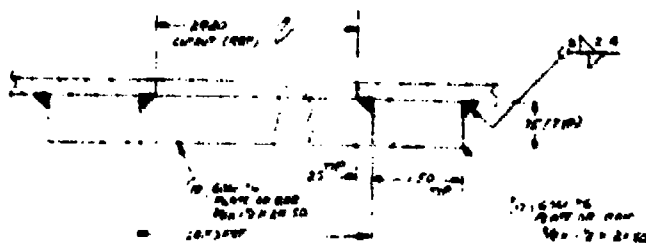

100 1/2 DIA  
W/C REF

100 1/2 DIA  
W/C REF

100 1/2 DIA  
W/C REF

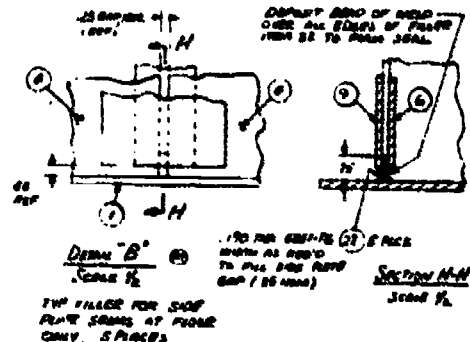
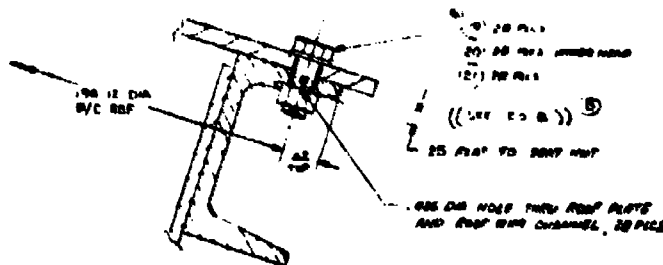

SECTION G-G  
SCALE 1/2  
(TYP 28 PLS ON ROOF ONLY)

- WELD JOINTS SHALL BE MADE TO ALL INDICES FROM FULL PENETRATING AND SHOWN WITH DIMENSIONS INDICATED. WELDING SHALL BE DONE IN ACCORDANCE WITH THE SPECIFICATIONS.
- ALL EXTERIOR WALL AND FLOOR JOINTS SHALL BE CONTINUOUS AND WELDED TOGETHER IN ACCORDANCE WITH THE SPECIFICATIONS OR SHALL BE COVERED WITH WELD.
- ANY INDENTATIONS OR CRACKS IN WALL SHALL BE F.O.D. MORE THAN 1/8" DEEP SHALL BE REPAIRED WITH WELD.
- CORNER MUST BE OBTAINED WHEN LIFTING TANK WITH BE SOLETS ONLY LIFTING POINTS TO TOP EDGE OF TANK ARE TO BE USED TO LIFT COMPLETE TANK. CORNER MUST BE 45 DEGREE ANGLE OF LIFTING POINTS TO CORNER TO BE 180 DEGREE AS SHOWN IN DRAWING.

| NO. | DESCRIPTION | QTY | UNIT | REMARKS |
|-----|-------------|-----|------|---------|
| 1   | ...         | ... | ...  | ...     |
| 2   | ...         | ... | ...  | ...     |
| 3   | ...         | ... | ...  | ...     |
| 4   | ...         | ... | ...  | ...     |
| 5   | ...         | ... | ...  | ...     |
| 6   | ...         | ... | ...  | ...     |
| 7   | ...         | ... | ...  | ...     |
| 8   | ...         | ... | ...  | ...     |
| 9   | ...         | ... | ...  | ...     |
| 10  | ...         | ... | ...  | ...     |
| 11  | ...         | ... | ...  | ...     |
| 12  | ...         | ... | ...  | ...     |
| 13  | ...         | ... | ...  | ...     |
| 14  | ...         | ... | ...  | ...     |
| 15  | ...         | ... | ...  | ...     |
| 16  | ...         | ... | ...  | ...     |
| 17  | ...         | ... | ...  | ...     |
| 18  | ...         | ... | ...  | ...     |
| 19  | ...         | ... | ...  | ...     |
| 20  | ...         | ... | ...  | ...     |
| 21  | ...         | ... | ...  | ...     |
| 22  | ...         | ... | ...  | ...     |
| 23  | ...         | ... | ...  | ...     |
| 24  | ...         | ... | ...  | ...     |
| 25  | ...         | ... | ...  | ...     |
| 26  | ...         | ... | ...  | ...     |
| 27  | ...         | ... | ...  | ...     |
| 28  | ...         | ... | ...  | ...     |
| 29  | ...         | ... | ...  | ...     |
| 30  | ...         | ... | ...  | ...     |

|   |           |                     |                   |                |
|---|-----------|---------------------|-------------------|----------------|
| FACTORY NO. 100   | CODE 1000 | PART NUMBER         | SPECIFICATION NO. | NON-CLASSIFIED |
| PART LIST   |           |                     |                   |                |
| MATERIAL SPECIFICATIONS                                     |           | WATER STORAGE TANK  |                   |                |
| DIMENSIONS ARE IN INCHES AFTER PLATING                      |           | E 97384 57413-40083 |                   |                |
| TOLERANCE   |           | MANUFACTURER        |                   |                |
| ANGLES TO 1/2 IN. DECIMAL FOR 1/2 IN. SPAC. 3/16 IN.        |           | DATE                |                   |                |
| MATERIAL  |           | DRAWN BY            |                   |                |
| ALL DIM. AND ANG. TO BE AS SHOWN UNLESS OTHERWISE SPECIFIED |           | CHECKED BY          |                   |                |
| BEST COPY USED ON APPLICATION                               |           | APPROVED BY         |                   |                |

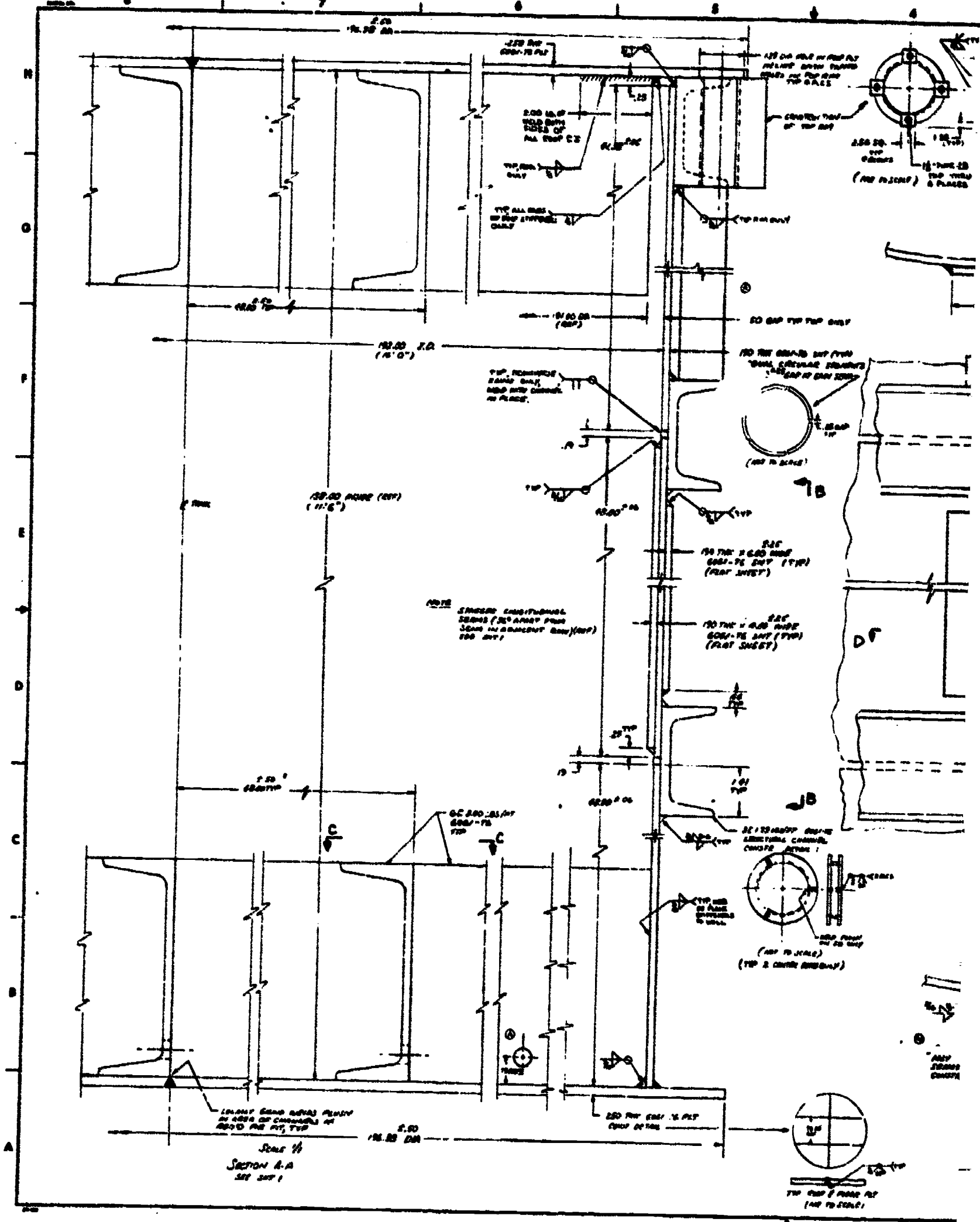

Scale 1/8"  
SECTION A-A  
SEE SHEET 1





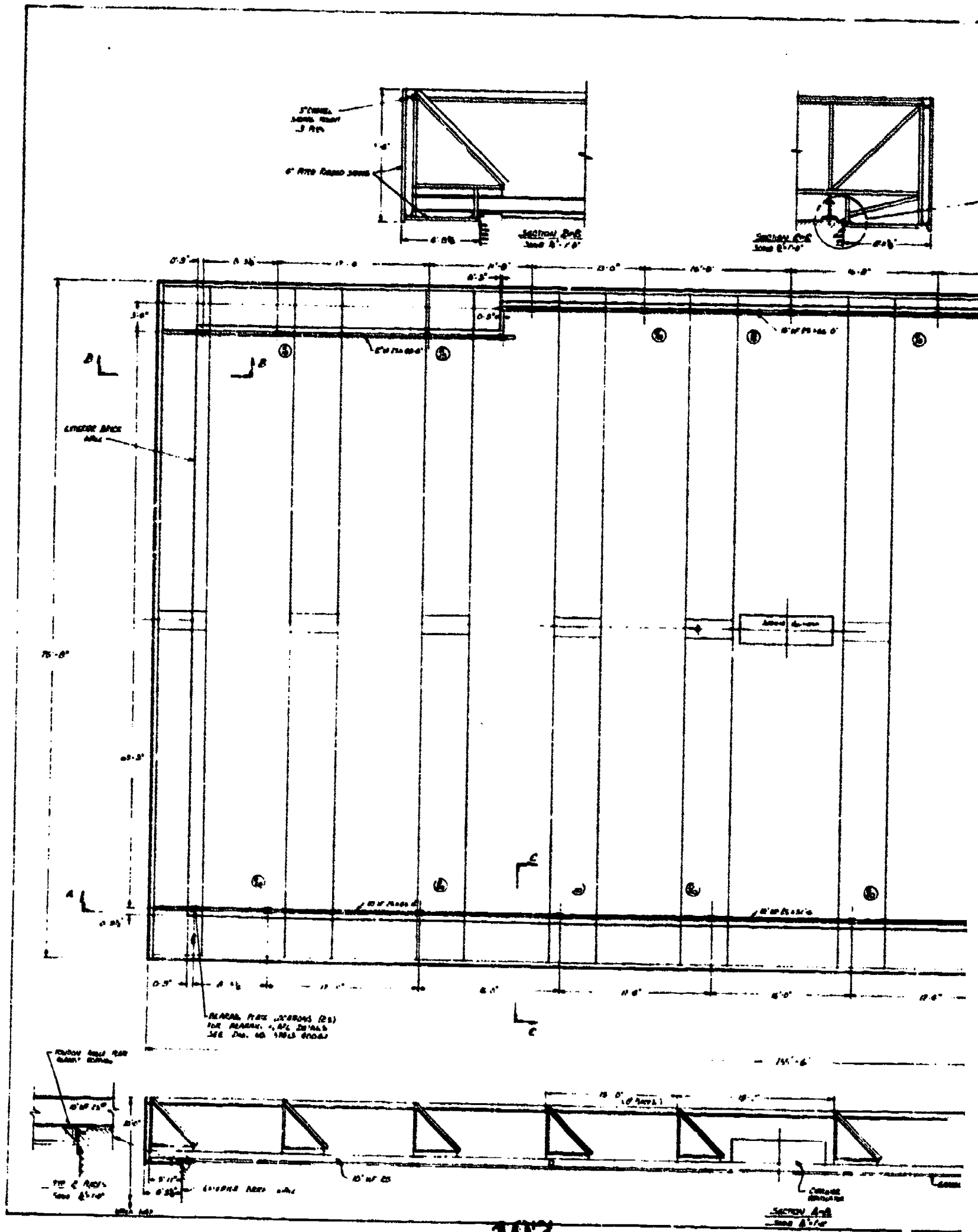

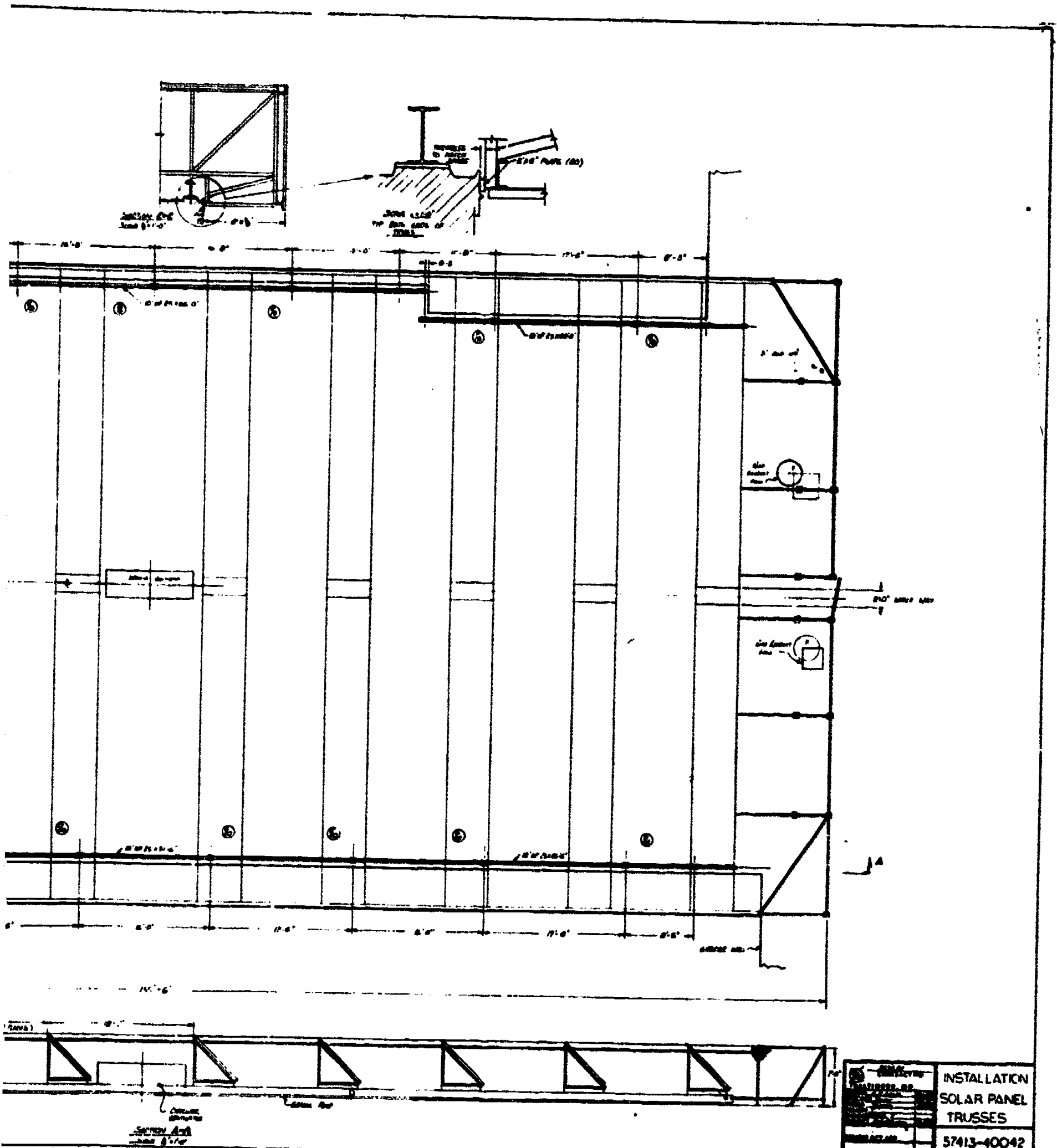

|             |              |
|-------------|--------------|
| ERIC        | INSTALLATION |
| SOLAR PANEL | SOLAR PANEL  |
| TRUSSES     | TRUSSES      |
| 57413-40042 | 57413-40042  |

SYMBOLS/NOTES

1. FOR SURFACE-TYPE TEMPERATURE TRANSDUCERS, USE EPOXY ADHESIVE.
2. FOR IMMERSION-TYPE TEMPERATURE TRANSDUCERS, DRILL & TAP  $\frac{1}{8}$ -27NPT. INSERT SWAGelok MALE CONNECTOR NO. 800-1-2-1T (USE PIPE THREAD SEALING COMPOUND).
3. SURFACE-TYPE TEMPERATURE TRANSDUCER  
TEMPLINE INC.  
NO. AP-250-250-100-2
4. IMMERSION-TYPE TEMPERATURE TRANSDUCER  
TEMPLINE INC.  
NO. IP-632-100-4-2

TP - TEST PANEL. SURFACE TRANSDUCERS LOCATED IN POSITIONS ①, ②, ③, ④, ⑤ & ⑥ (SEE DETAIL B), IN LOCATIONS L1 & L5 (SEE DETAIL A). ALSO SURFACE TRANSDUCERS LOCATED IN POSITION ⑦, IN LOCATIONS L2, L3, L4 & L6.

● - WATER TEMPERATURE IN & OUT OF EACH  $\frac{1}{2}$  COLLECTOR BANK ((18)  $\frac{1}{2}$  BANKS). USE IMMERSION-TYPE TRANSDUCER. DRILL & TAP HEADER IN LOCATION INDICATED (SEE NOTE 2). TYPICAL, 36 PLACES.

■ - WATER TEMPERATURE IN & OUT OF EACH SOLAR COLLECTOR ((1) BANK, 18 SOLAR COLLECTORS). USE IMMERSION-TYPE TRANSDUCER. DRILL & TAP HEADER IN LOCATIONS INDICATED (SEE NOTE 2). TYPICAL, 36 PLACES.

▲ - WATER TEMPERATURE IN & OUT OF TOTAL SOLAR COLLECTOR SYSTEM. USE IMMERSION-TYPE TRANSDUCER. DRILL & TAP HEADER IN LOCATIONS INDICATED (SEE NOTE 2). TYPICAL, 3 PLACES.

MP - MONITORING PANEL. USE SURFACE-TYPE TRANSDUCER. MOUNT TRANSDUCER IN POSITION ⑧, LOCATION L3 ONLY. TYPICAL, 6 PLACES.

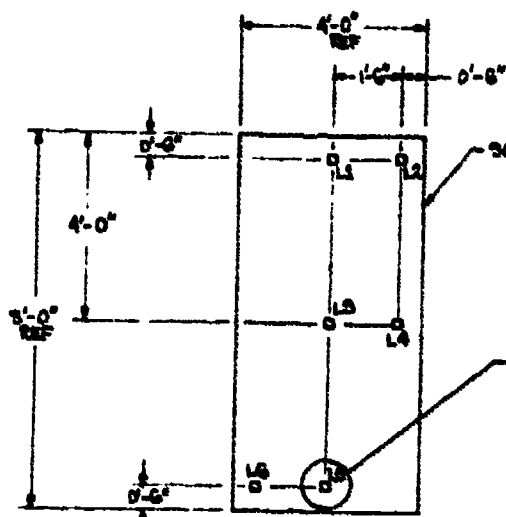
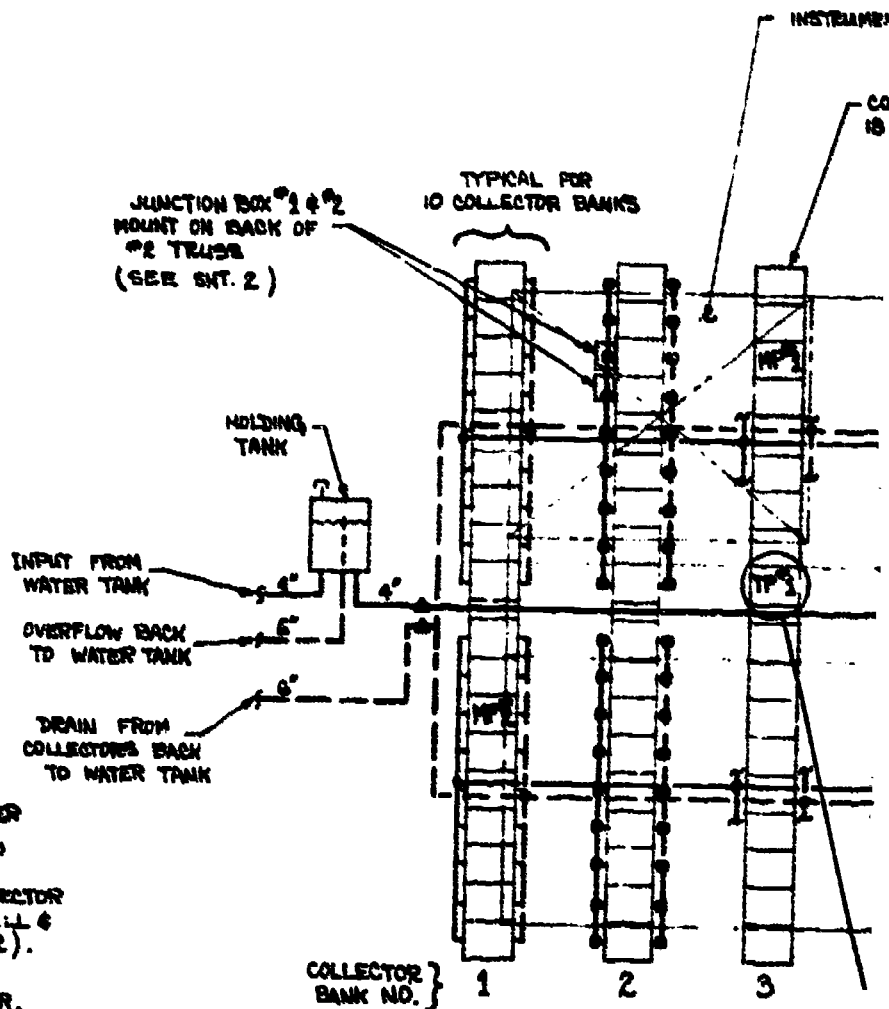

DETAIL "A"

NO SCALE

LOCATION OF SURFACE TEMPERATURE TRANSDUCERS

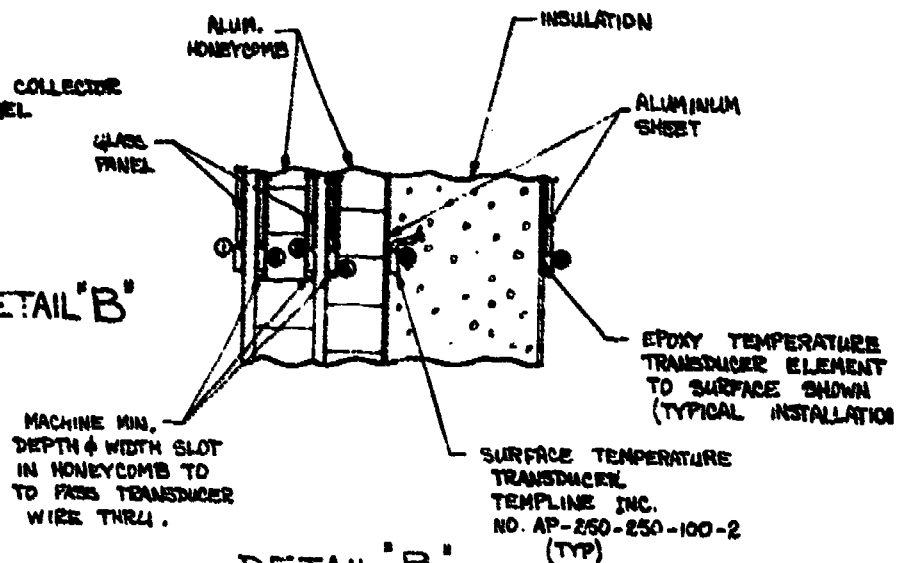

DETAIL "B"

SCALE: FULL

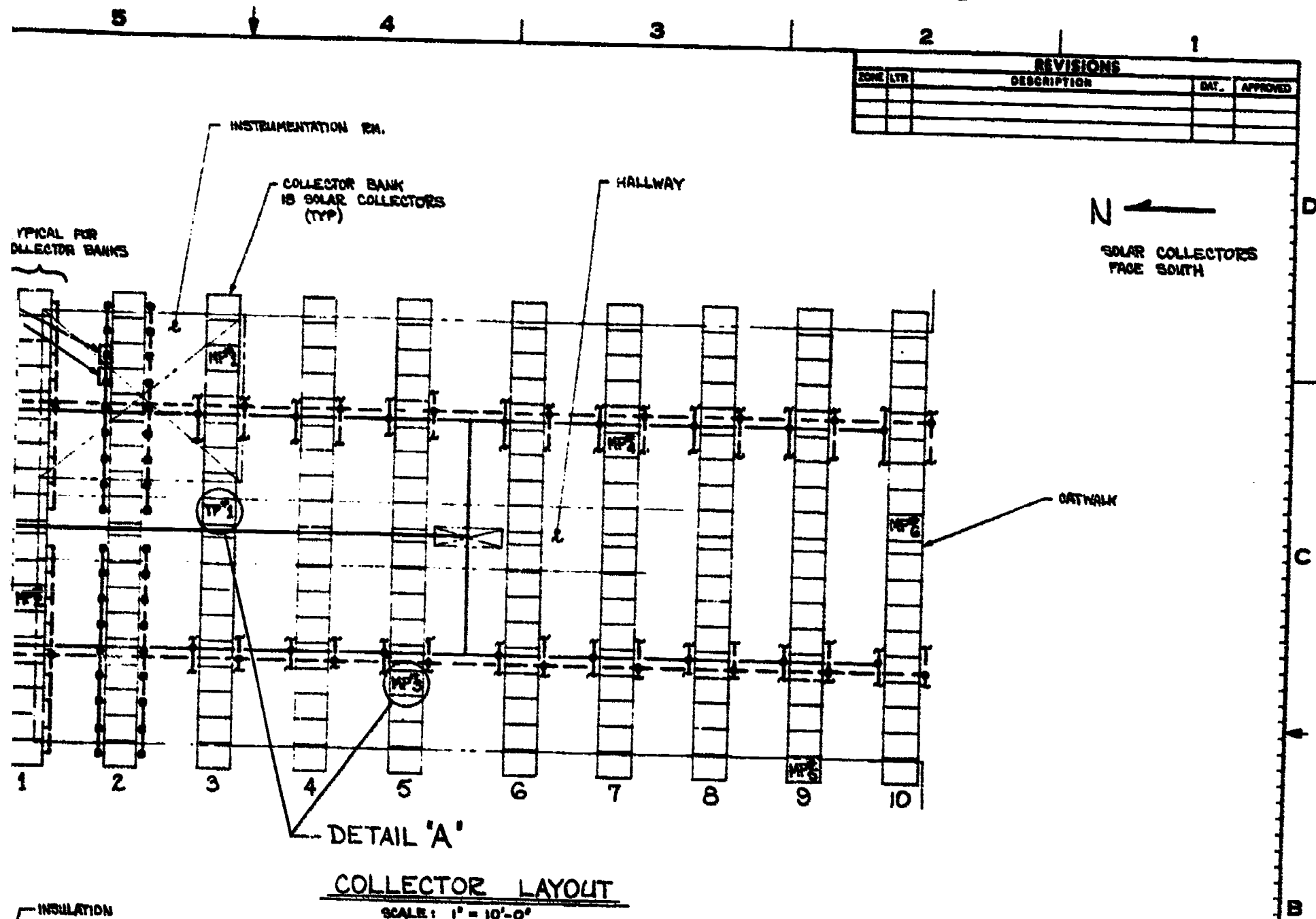

| REVISIONS |     |             |      |
|-----------|-----|-------------|------|
| ZONE      | LTR | DESCRIPTION | DATE |
|           |     |             |      |
|           |     |             |      |
|           |     |             |      |

TYPICAL FOR COLLECTOR BANKS

INSTRUMENTATION RA.

COLLECTOR BANK IS SOLAR COLLECTORS (TYP)

HALLWAY

N  
SOLAR COLLECTORS FACE SOUTH

CATWALK

DETAIL 'A'

COLLECTOR LAYOUT

SCALE: 1" = 10'-0"

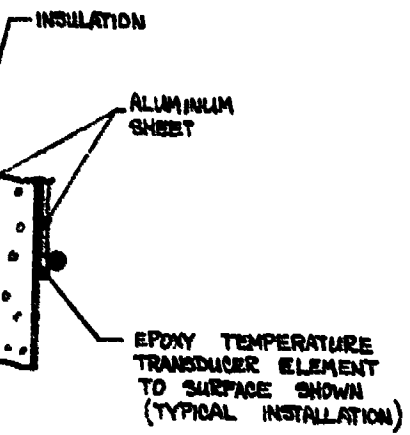

SURFACE TEMPERATURE TRANSDUCER  
TEMPLINE INC.  
NO. AP-250-250-100-2  
(TYP)

|             |         |   |
|-------------|---------|---|
|             |         | UNLESS OTHERWISE SPECIFIED DIMENSIONS ARE IN INCHES AFTER PLAYING TOLERANCE |
|             |         |   |
|             |         | ANGLES  |
|             |         | DECIMAL   |
|             |         | 2 PLACE   |
|             |         | 3 PLACE   |
|             |         | MATERIAL:   |
|             |         |   |
| NEXT ASSY   | USED ON |   |
| APPLICATION |         |   |

| ITEM NO.   | QTY REQ | CODE IDENT | PART NUMBER | SPECIFICATION NO.                           | NOMENCLATURE |
|--|---------|------------|-------------|---|--------------|
| PARTS LIST   |         |            |             |   |              |
| REF SCALE: 1" = 10'-0"   |         |            |             |   |              |
| CW-3492-04<br>CONTRACT NO.<br>BALTIMORE, MD.<br>DRAWN BY: J. B. BISHOP<br>CHECKED BY: J. B. BISHOP<br>DESIGN BY: J. B. BISHOP<br>ENGINEERING DEPARTMENT<br>DATE: 11/2/72 |         |            |             |   |              |
| INSTRUMENTATION - LAYOUT & SCHEMATIC SOLAR COLLECTOR SYSTEM  |         |            |             | SIZE: CODE IDENT NO.<br>D 97384 57413-40069 |              |
| APPROVAL   |         | DATE       |             | SCALE NOTED                                 |              |
| SHEET 1 OF 2   |         |            |             |   |              |

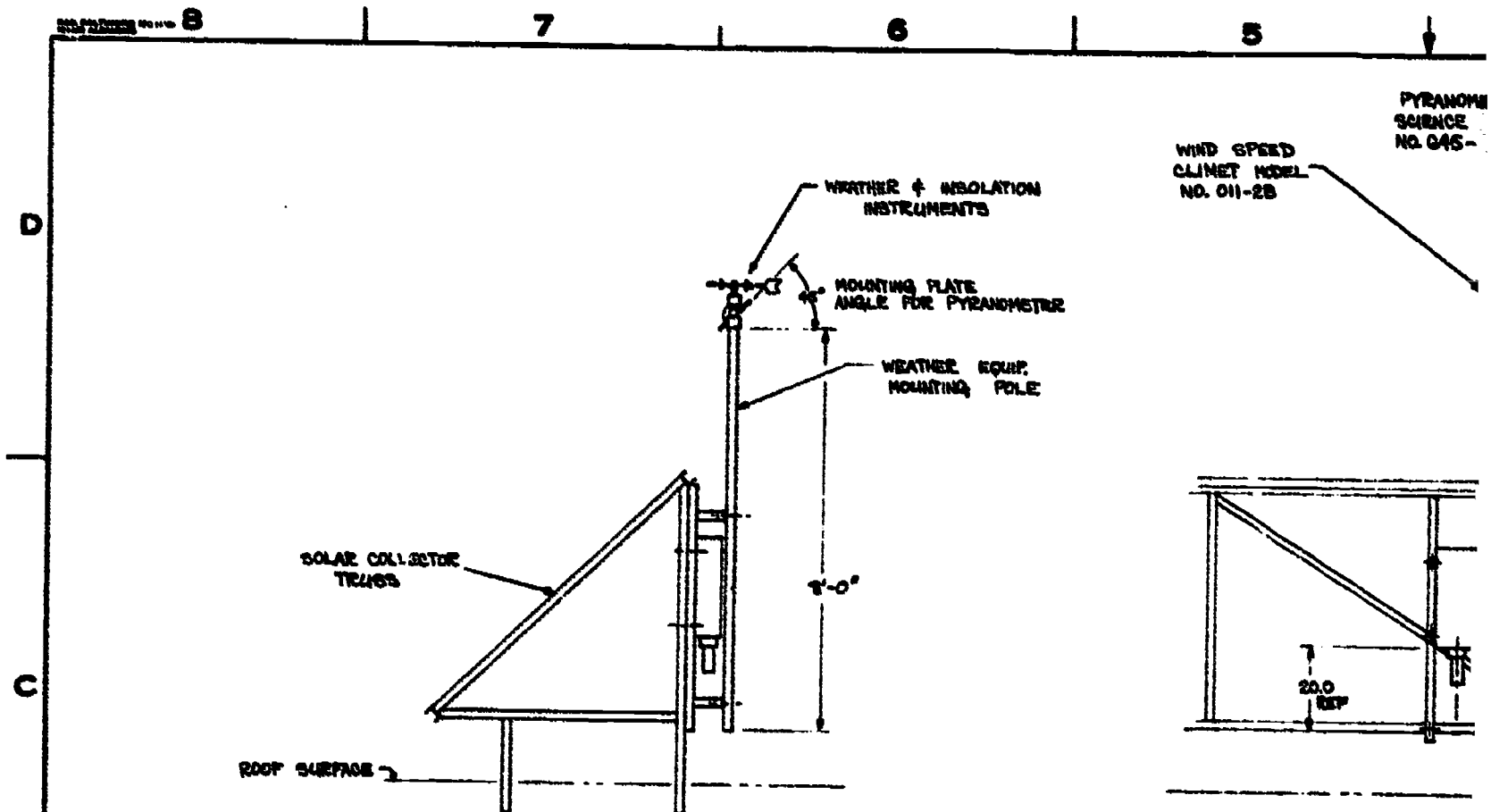

INSTALLATION - JUNCTION BOX

SCALE : 1" = 20"

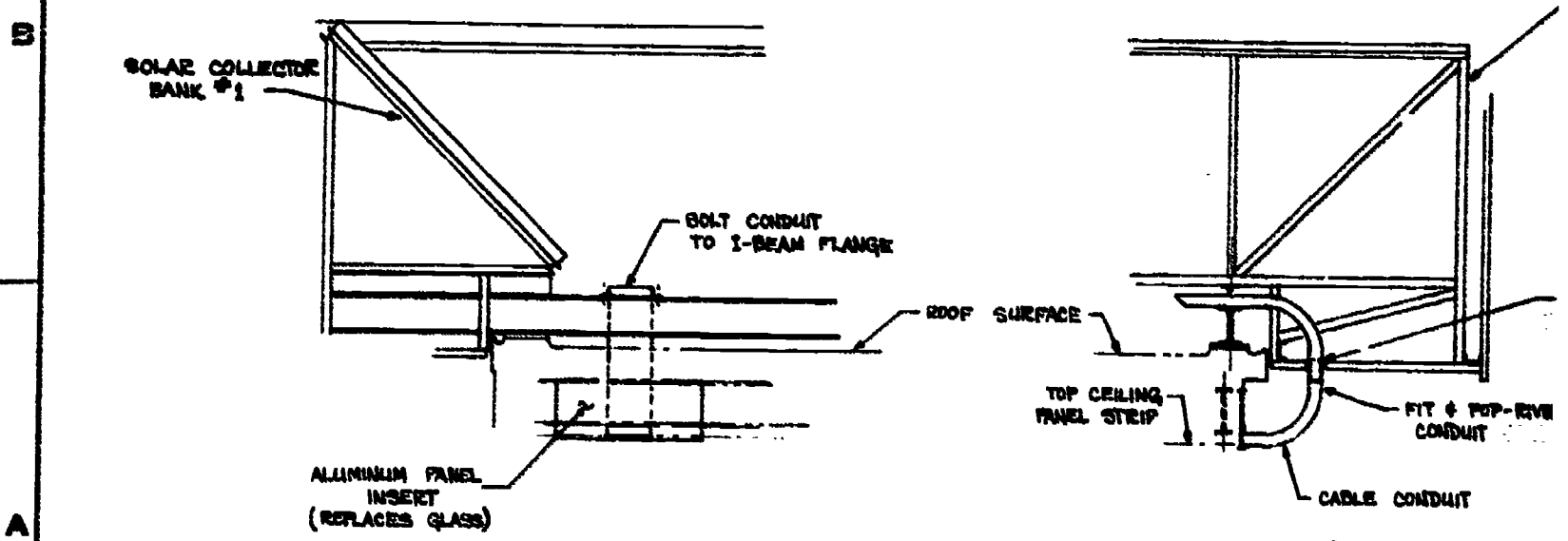

INSTALLATION - CABLE CONDUIT TO INSTRUMENT ROOM

SCALE : 1/2" = 1'-0"

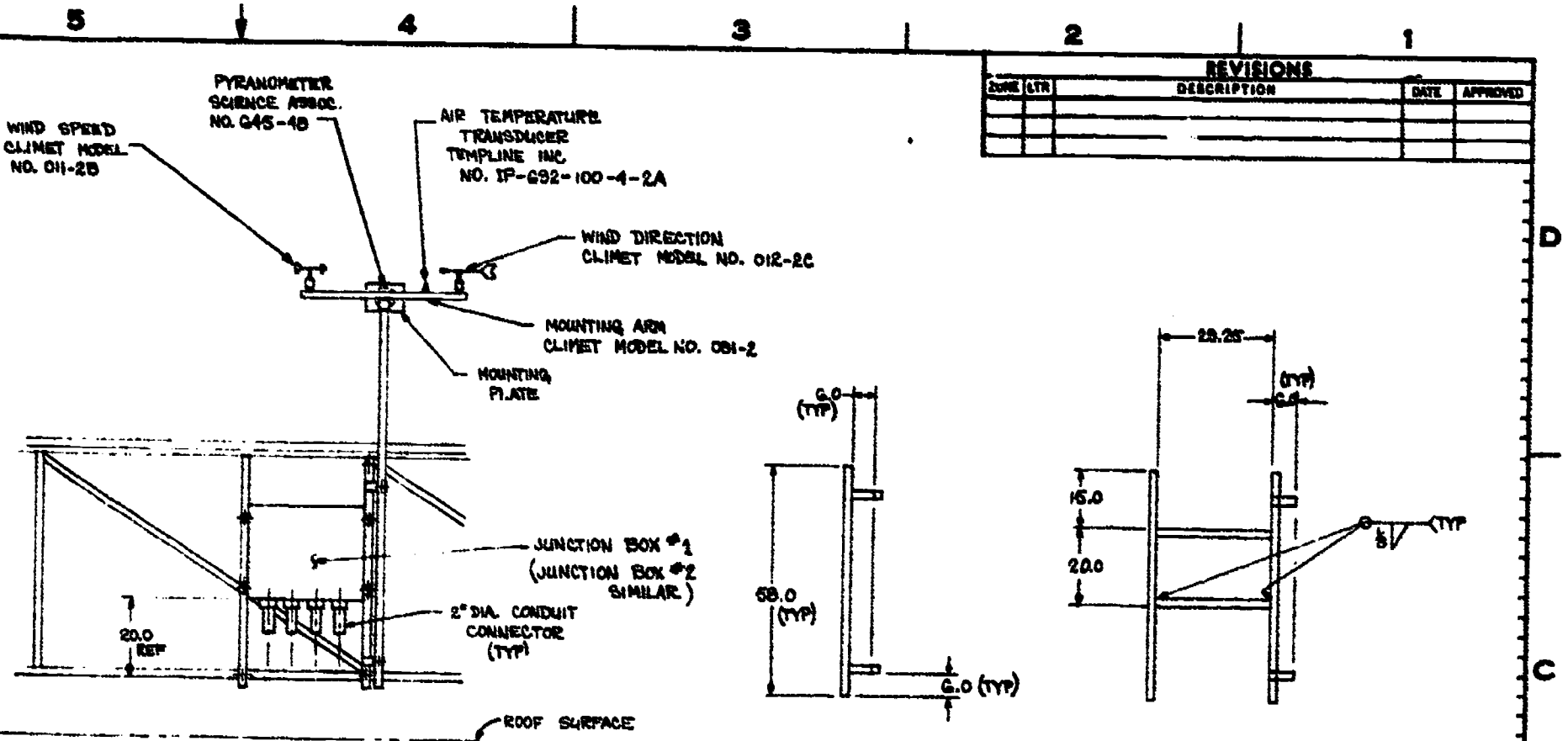

| REVISIONS  |             |      |          |
|------------|-------------|------|----------|
| ZONE (LTR) | DESCRIPTION | DATE | APPROVED |
|            |             |      |          |
|            |             |      |          |
|            |             |      |          |

**SUPPORT FRAME  
JUNCTION BOX**

SCALE : 1" = 20"  
 MAT'L : .12 x 2 x 2 SQ. STEEL TUBING  
 FINISHING : PRIME & PAINT BLUE/GREEN.

**JUNCTION BOX**

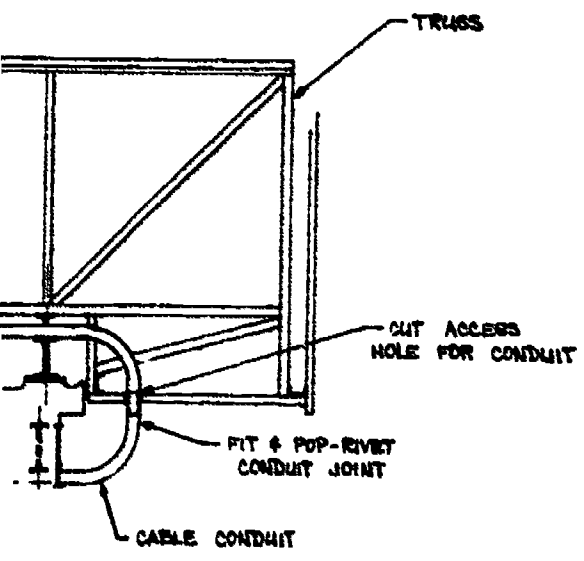

| ITEM NO.   | QTY REQ | CODE IDENT | PART NUMBER | SPECIFICATION NO. | NOMENCLATURE |
|------------|---------|------------|-------------|-------------------|--------------|
| PARTS LIST |         |            |             |                   |              |
|            |         |            |             |                   |              |
|            |         |            |             |                   |              |
|            |         |            |             |                   |              |

|   |  |  |
|---|--|--|
| <p>UNLESS OTHERWISE SPECIFIED<br/>         DIMENSIONS ARE IN INCHES<br/>         AFTER PLATING<br/> <b>TOLERANCE</b></p> <p>ANGLES: ~<br/>         DECIMAL: ~<br/>         FRACTION: ~</p> <p><b>MATERIAL:</b> ~</p> <p>NEXT ASSY: ~     USED ON: ~</p> <p>APPLICATION: ~</p> | <p>CH-3492-04<br/>         CONTINENT MET.<br/>         BALTIMORE, MD.<br/>         DRAWN BY: J. LINDNER<br/>         CHECKED BY: J. J. K.     11/2/77<br/>         DESIGNED BY: J. J. K.<br/>         ENGINEERED BY: J. J. K.<br/>         PROJECT: Solar</p> <p>DATE: ~     SCALE: AS NOTED</p> | <p><b>INSTRUMENTATION<br/>         INSTALLATION &amp; DETAILS<br/>         SOLAR COLLECTOR SYSTEM</b></p> <p>REF: CODE IDENT NO.<br/> <b>D 97384 57413-40069</b></p> <p>SHEET 2 OF 2</p> |
|---|--|--|



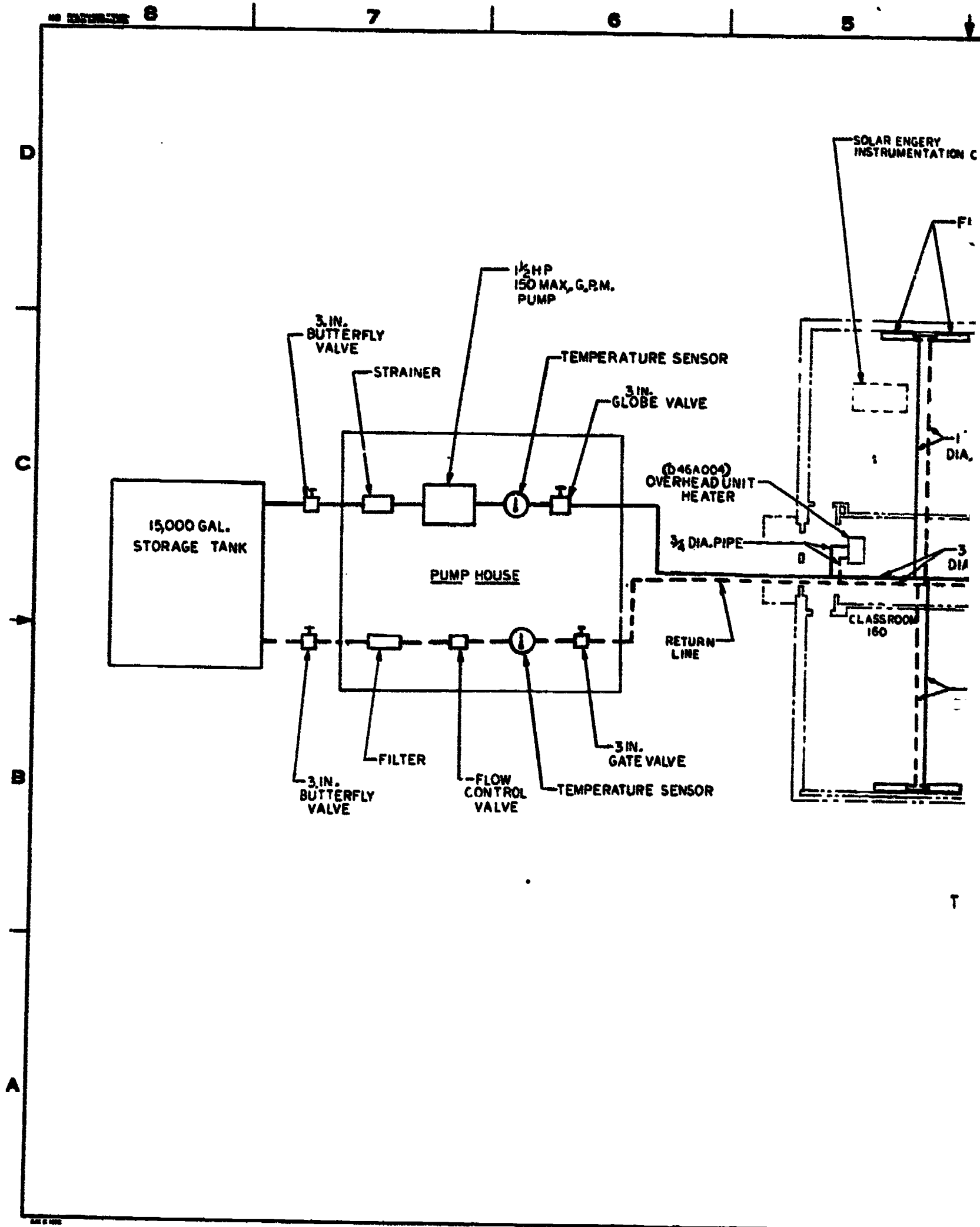

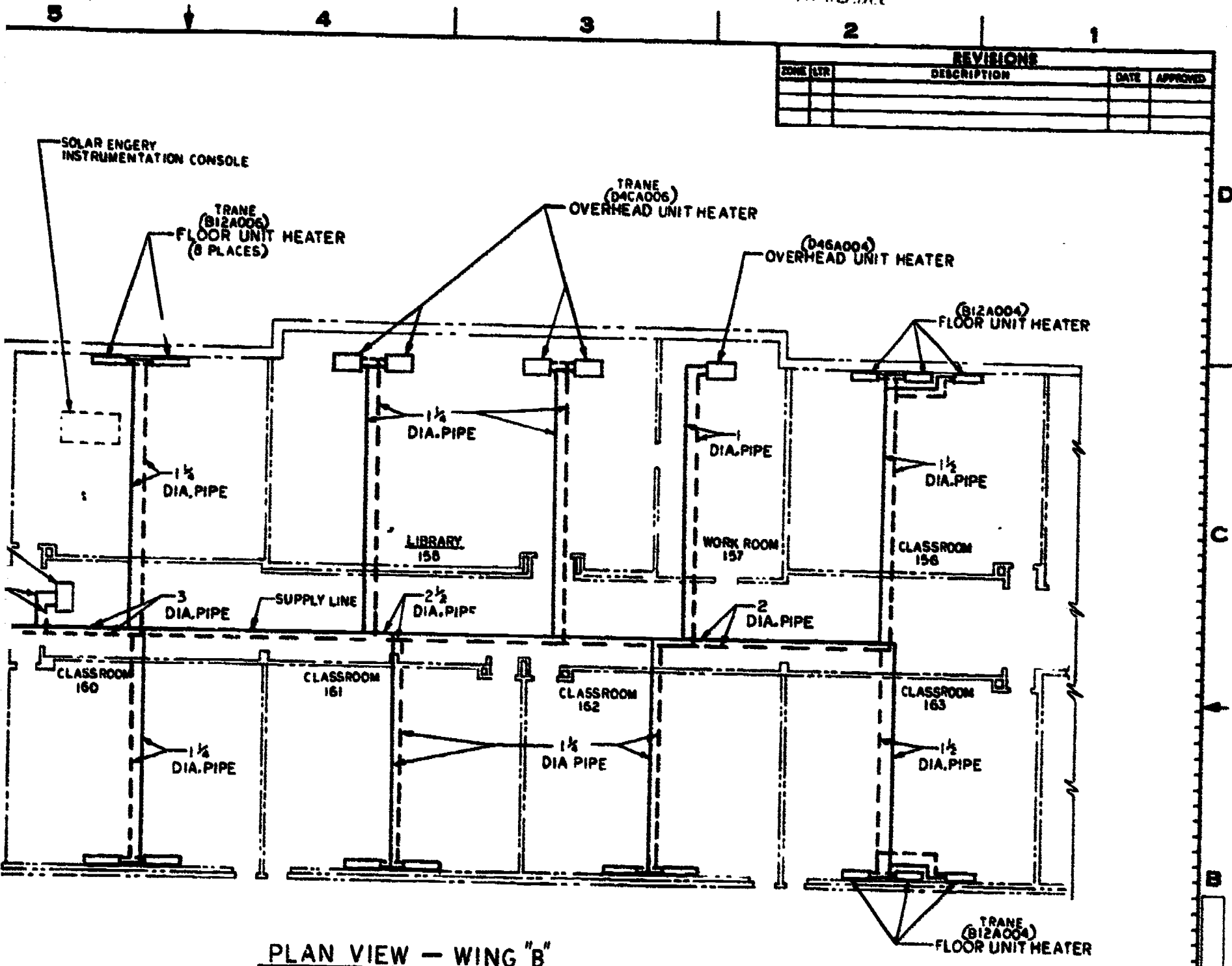

| REVISIONS |     |             |      |          |
|-----------|-----|-------------|------|----------|
| ZONE      | STR | DESCRIPTION | DATE | APPROVED |
|           |     |             |      |          |
|           |     |             |      |          |
|           |     |             |      |          |

PLAN VIEW - WING "B"

TIMONIUM ELEMENTARY SCHOOL -NO SCALE

ALL PIPE RUNS SHOWN ARE IN  
CEILING OF SCHOOL

TOTAL AREA HEATED = 10,000 SQ.FEET

57413-40114

| ITEM NO. | QTY REQ | CODE IDENT | PART NUMBER | SPECIFICATION NO. | NOMENCLATURE |
|----------|---------|------------|-------------|-------------------|--------------|
|----------|---------|------------|-------------|-------------------|--------------|

PARTS LIST

|                    |         |   |
|--------------------|---------|---|
|                    |         | UNLESS OTHERWISE SPECIFIED<br>DIMENSIONS ARE IN INCHES<br>AFTER PLATING |
|                    |         | <b>TOLERANCE</b>  |
|                    |         | ANILES: _____   |
|                    |         | DECIMAL: _____  |
|                    |         | 1/8 PLACE: _____  |
|                    |         | 1/16 PLACE: _____   |
|                    |         | <b>MATERIAL:</b>  |
| NEXT ASSY          | USED ON |   |
| <b>APPLICATION</b> |         |   |

|   |   |
|---|---|
| <p>CW 3492<br/>CONTRACT NO.</p> <p>BALTIMORE, MD.</p> <p>DRAWN BY: J. [Signature]<br/>CHECKED BY: [Signature]<br/>DESIGN BY: [Signature]<br/>ENGINEER: [Signature]<br/>PROJECT: [Signature]</p> | <p><b>PIPING SCHEMATIC</b></p> <p>SIZE: D<br/>CODE IDENT NO.: 97384<br/>57413-40114</p> |
| <p>DATE: _____</p> <p>SCALE: AS SHOWN</p>   | <p>SHEET / OF /</p>   |

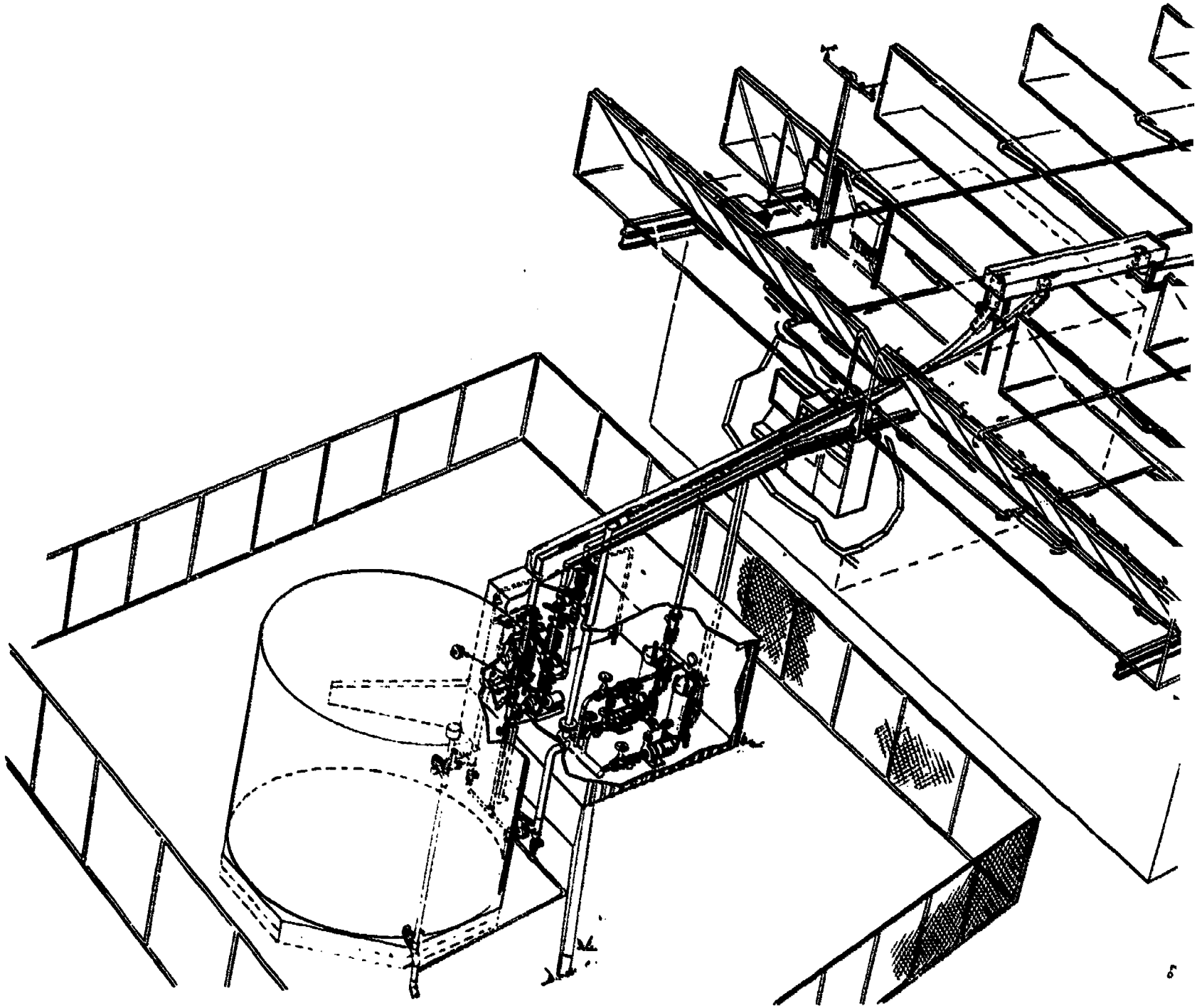

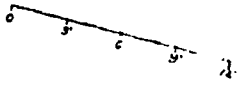
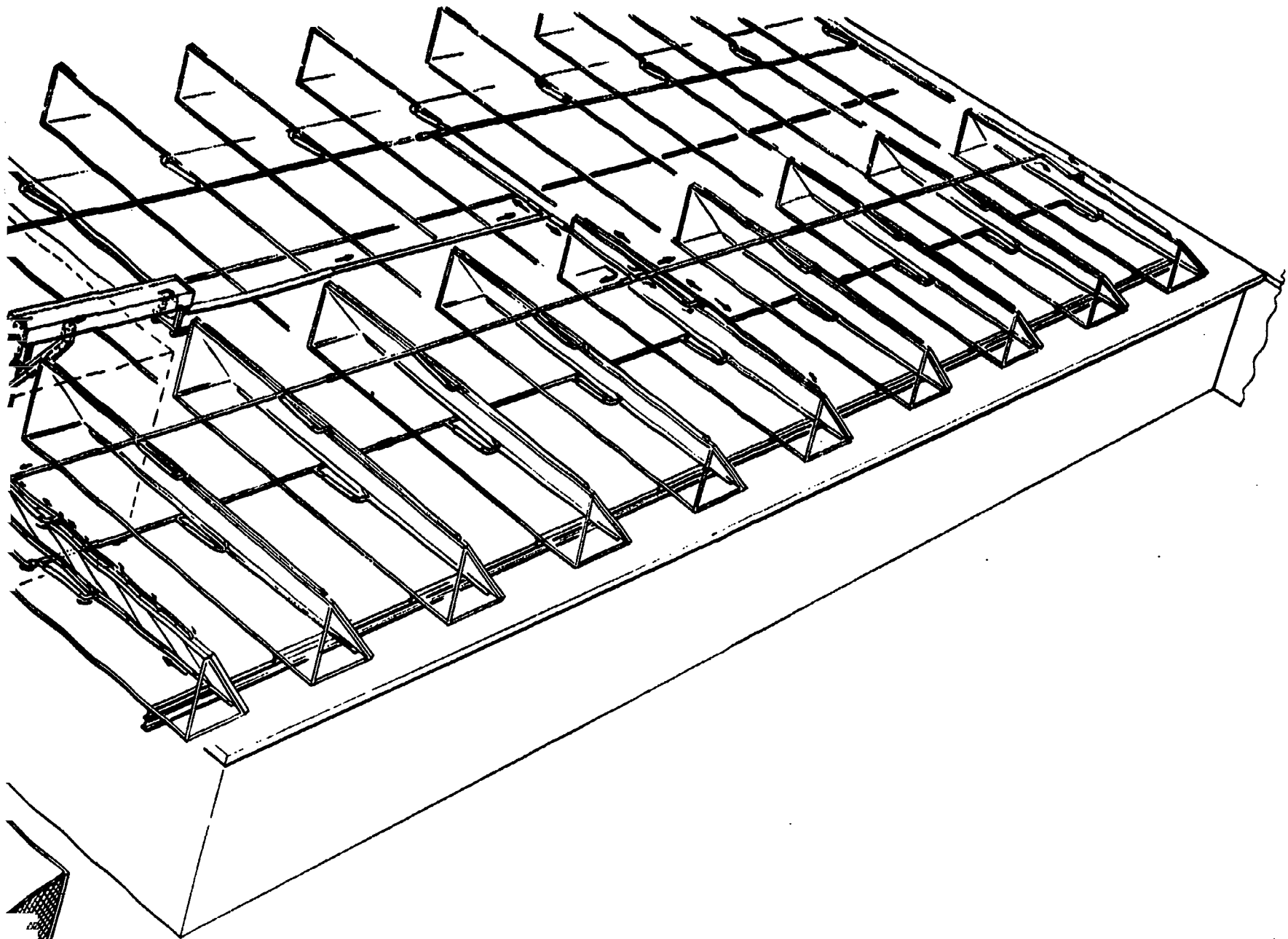

| FIGURE        | CODE | PART NUMBER           | SPECIFICATION NO. | INDUSTRY |
|---------------|------|-----------------------|-------------------|----------|
| 1             |      |                       |                   |          |
| CORRECTING    |      | SOLAR PLUMBING SYSTEM |                   |          |
| CALIBRATED BY |      | 97384                 | 57413-4020        |          |
| MANUFACTURE   |      |                       |                   |          |

## **APPENDIX B**

### **CHAR T OF DATA FOR A TYPICAL DAY OF OPERATION**

| <b>Recording Channels</b>               | <b><u>Mode of Measurement</u></b> |
|---|-----------------------------------|
| 1. Steam Flow                           | % of 2000 lb/hr                   |
| 2. School Flow                          | % of 125 gpm                      |
| 3. Collector Flow                       |                                   |
| 4. Tank Temperature - Top               | C <sup>o</sup>                    |
| 5. Tank Temperature - Bottom            | C <sup>o</sup>                    |
| 6. School Inlet                         | C <sup>o</sup>                    |
| 7. School Outlet                        | C <sup>o</sup>                    |
| 8. Collector Inlet                      | C <sup>o</sup>                    |
| 9. Collector Outlet                     | C <sup>o</sup>                    |
| 10. Insolation                          | % of 440                          |
| 11. Panel Surface Temperature #2        | C <sup>o</sup>                    |
| 12. Outside Ambient Temperature         | F <sup>o</sup>                    |
| 13. Panel Surface Temperature #3        | C <sup>o</sup>                    |
| 14. Panel Surface Temperature #4        | C <sup>o</sup>                    |
| 15. Float Level Tank                    | Water height in inches            |
| 16. Storage Tank Level                  | % of 144 inches                   |
| 17. Steam Inlet Temperature             | C <sup>o</sup>                    |
| 18. Steam Outlet Temperature            | C <sup>o</sup>                    |
| 19. Collector Row Manifold (7 W inlet)  | C <sup>o</sup>                    |
| 20. Collector Row Manifold (7 W outlet) | C <sup>o</sup>                    |

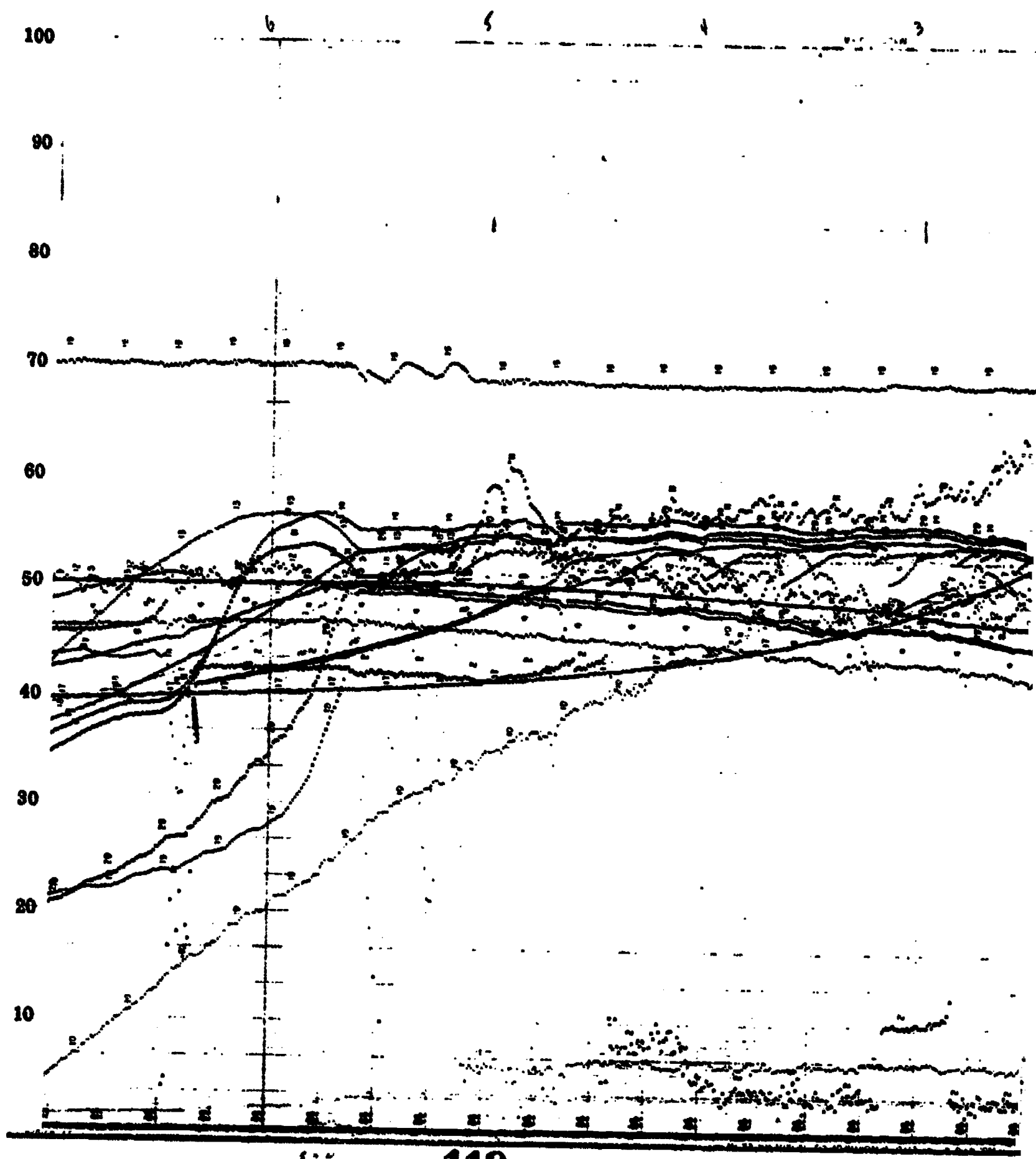

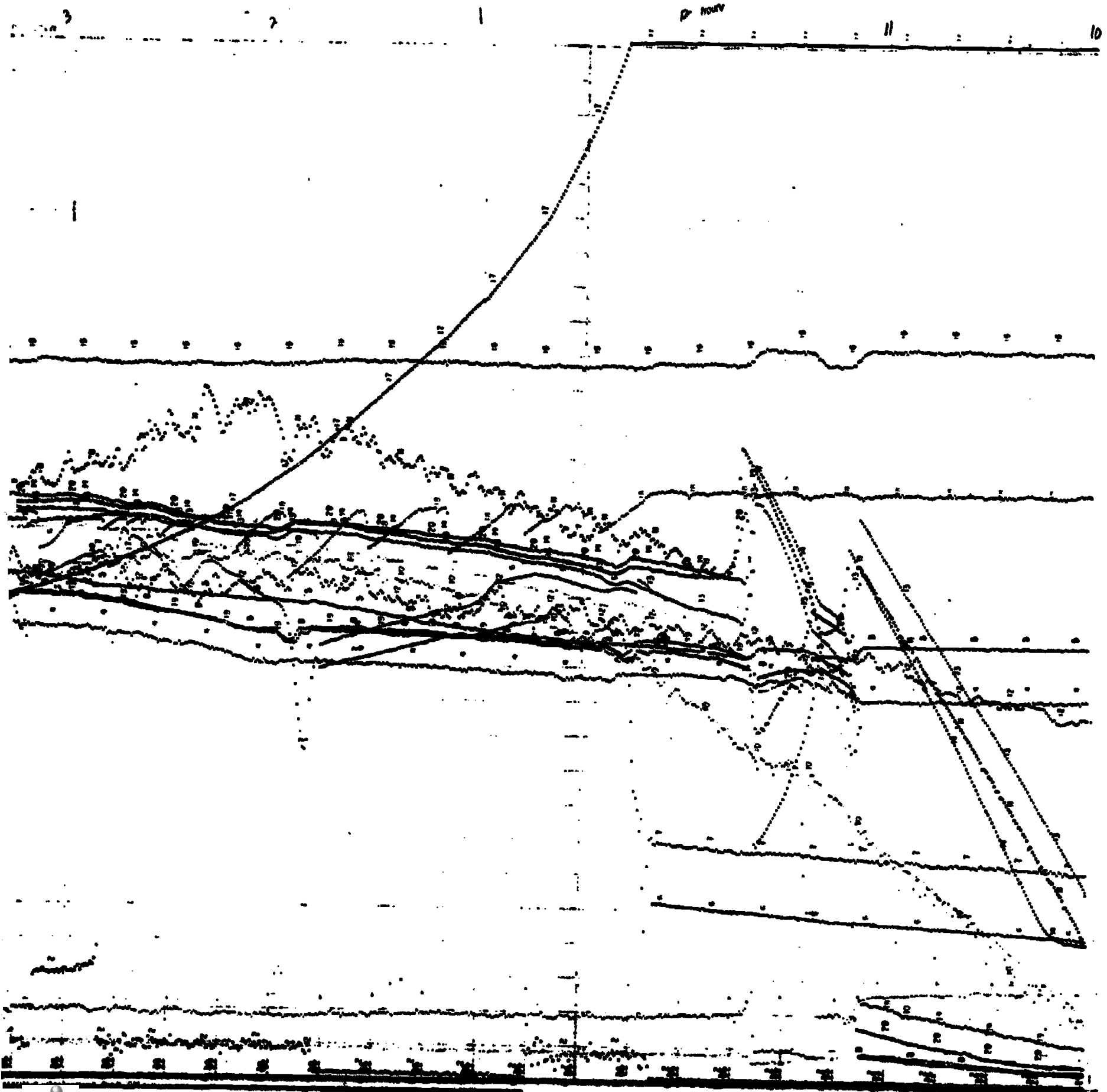

**APPENDIX C**

**WATER ANALYSIS REPORTS**

**107**

**121**



**WATER ANALYSIS REPORT**

**BEST COPY AVAILABLE**

DUPLICATE



04/04/74

CULLIGAN USA NORTHBROOK, ILLINOIS - (312) 498-2000 • SAN BERNARDINO, CALIFORNIA - (714) 887-2557

|   |         |          |                             |  |
|---|---------|----------|-----------------------------|--|
| CITY OF GREATER BALTIMORE<br>DIV OF ANN-CARING<br>6064 BEL-AIR RD<br>BALTIMORE MD 21246 |         |          | ANALYSIS NUMBER<br>CONSUMER | N 303094 1<br>A A I CLKP<br>LUTHERVILLE-TIMONIUM MD<br>21093 |
| FILE NUMBER   | SAMPLED | RECEIVED | US ZIP OF SAMPLE LOCATION   | SOURCE   |
| 14-023 LH   | 3/26/74 | 3/28/74  | 21093                       | MUNICIPAL / --   |
|   |         |          | SAMPLING POINT              | SAMPLE CLERK   |
|   |         |          | SAMPLE REPRESENTS           | DEIONIZED WATER  |

\* EXPRESSED AS CALCIUM CARBONATE

|                  |      |      |                        |          |
|------------------|------|------|------------------------|----------|
| TURBIDITY        |      |      |                        |          |
| BEFORE FILTERING |      | JTU  | PH                     | 7.5      |
| AFTER FILTERING  |      | JTU  | RESISTIVITY (CMMS/CM)  | 117,000  |
| TEMP             |      |      | CHEMICAL OXYGEN DEMAND | 1.3 MG/L |
| TOTAL HARDNESS * | 1.2  | MG/L |                        |          |
| IRON (FE)        | 0.0  | MG/L | NITRATE (N)            | MG/L     |
| MANGANESE (MN)   | 0.0  | MG/L | SILICA                 | 2.0 MG/L |
| COPPER (CU)      | 0.02 | MG/L |                        |          |
| ZINC (ZN)        | 0.02 | MG/L |                        |          |

|               |           |                  |      |
|---------------|-----------|------------------|------|
| -CATIONS- *   |           | -ANIONS- *       |      |
| CALCIUM       | 0.27 MG/L | CHLORIDE         | MG/L |
| MAGNESIUM     | 0.90 MG/L | SULFATE          | MG/L |
| SODIUM        | 1.23 MG/L | NITRATE          | MG/L |
| POTASSIUM     | 0.00 MG/L | HYDRATE ALK.     | MG/L |
|               |           | CARBONATE ALK.   | MG/L |
|               |           | BICARBONATE ALK. | MG/L |
| TOTAL CATIONS | MG/L      | TOTAL ANIONS     | MG/L |

JAMES A. O'MALLEY  
CHEMIST

**WATER ANALYSIS REPORT**

**BEST COPY AVAILABLE**



DUPLICATE

04/18/74

CULLIGAN USA, NORTHBROOK, ILLINOIS - (312) 498-2000 • SAN BERNARDINO, CALIFORNIA - (714) 887-2557

CWG OF GREATER BALTIMORE  
 CIV OF ANN-CARING.  
 6064 BEL-AIR RD  
 BALTIMORE MD 21236

ANALYSIS NUMBER N 365050 I  
 CONSUMER A A I CORP  
 LUTHERVILLE-TIMONIUM MD  
 US ZIP OF SAMPLE LOCATION 21093  
 SOURCE MUNICIPAL / --  
 SAMPLING POINT SAMPLE CCK  
 SAMPLE REPRESENTS DEIONIZED WATER

FILE NUMBER 14-020 LM  
 SAMPLED 4/12/74  
 RECEIVED 4/15/74

\* EXPRESSED AS CALCIUM CARBONATE

TURBIDITY BEFORE FILTERING JTU PH 7.5  
 AFTER FILTERING JTU RESISTIVITY (CMHMS/CM) 76,000  
 COLOR CHEMICAL OXYGEN DEMAND 6.7 MG/L  
 TDS  
 TOTAL HARDNESS \* 1.5 MG/L  
 IRON (FE) C.C. MG/L NITRATE (N) MG/L  
 MANGANESE (MN) C.C. MG/L SILICA 6.0 MG/L  
 COPPER (CU) C.C. MG/L  
 ZINC (ZN) C.C. MG/L

-CATIONS- \* -ANIONS- \*  
 CALCIUM 0.39 MG/L CHLORIDE MG/L  
 MAGNESIUM 1.09 MG/L SULFATE MG/L  
 SODIUM 2.09 MG/L NITRATE MG/L  
 POTASSIUM 0.56 MG/L HYDROXIDE ALK. MG/L  
 CARBONATE ALK. MG/L  
 BICARBONATE ALK. MG/L  
 TOTAL CATIONS MG/L TOTAL ANIONS MG/L

JAMES A. O'PALLEY  
 CHEMIST



**WATER ANALYSIS REPORT**

**BEST COPY AVAILABLE**

DUPLICATE

**Culligan**

04/26/74

CULLIGAN USA, NORTHBROOK, ILLINOIS - (312) 498-2000 • SAN BERNARDINO, CALIFORNIA - (714) 887-2557

CWC OF GREATER BALTIMORE  
DIV OF ANN-CARING  
8564 BEL-AIR RD  
BALTIMORE MD 21236

ANALYSIS NUMBER N 365525 I  
CONSUMER A A I CORP  
LUTHERVILLE-TIMONIUM MD  
US ZIP OF SAMPLE LOCATION 21093  
SOURCE MUNICIPAL / --  
SAMPLING POINT SAMPLE COCK  
SAMPLE REPRESENTS DEIONIZED WATER

FILE NUMBER 15-070 LM  
SAMPLED RECEIVED  
4/22/74

\* EXPRESSED AS CALCIUM CARBONATE

TURBIDITY  
BEFORE FILTERING JTL PH 7.1  
AFTER FILTERING JTL RESISTIVITY (CMHMS/CM) 66,000  
COLOR CHEMICAL OXYGEN DEMAND 8.0 MG/L  
TDS  
TOTAL HARDNESS \* 1.5 MG/L  
IRON (FE) 0.0 MG/L NITRATE (N) MG/L  
MANGANESE (MN) 0.0 MG/L SILICA 3.5 MG/L  
COPPER (CU) 0.02 MG/L  
ZINC (ZN) 0.04 MG/L

-CATIONS- \*

CALCIUM 0.32 MG/L  
MAGNESIUM 1.12 MG/L  
SODIUM 2.16 MG/L  
POTASSIUM 0.28 MG/L

-ANIONS- \*

CHLORIDE MG/L  
SULFATE MG/L  
NITRATE MG/L  
HYDROXIDE ALK. MG/L  
CARBONATE ALK. MG/L  
BICARBONATE ALK. MG/L  
TOTAL ANIONS MG/L

TOTAL CATIONS MG/L

JAMES A. O'MALLEY  
CHEMIST

**WATER ANALYSIS REPORT**

**BEST COPY AVAILABLE**

DUPLICATE

*Culligan.*

05/09/74

CULLIGAN USA, NORTHBROOK, ILLINOIS - (312) 498-2000 • SAN BERNARDINO, CALIFORNIA - (714) 887-2657

CNC OF GREATER BALTIMORE  
DIV OF ANN-CARINC.  
8804 DEL-AIR RD  
BALTIMORE MD 21236

ANALYSIS NUMBER N 366382 C  
CONSUMER A A I CORP  
LUTHERVILLE-TIMONIUM MD  
US ZIP OF SAMPLE LOCATION 21093  
SOURCE MUNICIPAL / --  
SAMPLING POINT SAMPLE COCK  
SAMPLE REPRESENTS DEIONIZED WATER

FILE NUMBER 19-020 LM  
SAMPLED 5/01/74  
RECEIVED 5/06/74

**\* EXPRESSED AS CALCIUM CARBONATE**

|                  |      |          |                         |      |     |
|------------------|------|----------|-------------------------|------|-----|
| TURBIDITY        |      |          |                         |      |     |
| BEFORE FILTERING | 0.   | JTL      | PH                      | 8.0  |     |
| AFTER FILTERING  |      | JTU      | CONDUCTIVITY (MMHOS/CM) | 24.8 |     |
| COLOR            | 0.   |          | ESTIMATED T.O.S.        | 15.  | PPM |
| ODOR             |      | CHEMICAL | CHEMICAL OXYGEN DEMAND  | 12.  | PPM |
| TOTAL HARDNESS * | 0.2  | GPG      | COMPENSATED HARDNESS *  |      | GPG |
| IRON (FE)        | 0.0  | PPM      | NITRATE (N)             | NONE | PPM |
| MANGANESE (MN)   | 0.0  | PPM      | SILICA                  | 2.0  | PPM |
| COPPER (CU)      | 0.01 | PPM      |                         |      |     |
| ZINC (ZN)        | 0.04 | PPM      |                         |      |     |

**-CATIONS- \***

|                      |            |            |
|----------------------|------------|------------|
| CALCIUM              | 0.1        | GPG        |
| MAGNESIUM            | 0.1        | GPG        |
| SODIUM               | 0.3        | GPG        |
| POTASSIUM            | 0.0        | GPG        |
| <b>TOTAL CATIONS</b> | <b>0.5</b> | <b>GPG</b> |

**-ANIONS- \***

|                     |            |            |
|---------------------|------------|------------|
| CHLORIDE            | 0.0        | GPG        |
| SULFATE             |            | GPG        |
| NITRATE             |            | GPG        |
| HYDROXIDE ALK.      |            | GPG        |
| CARBONATE ALK.      |            | GPG        |
| BICARBONATE ALK.    | 0.5        | GPG        |
| <b>TOTAL ANIONS</b> | <b>0.5</b> | <b>GPG</b> |

**-FOR D.I. CALCULATIONS-**

|                 |      |   |                          |     |     |
|-----------------|------|---|--------------------------|-----|-----|
| SODIUM          | 60.  | % | WEAK BASE LOAD FACTOR X  | 0.0 | GPG |
| ALKALINITY      | 100. | % | CARBONIC ACID FORMED     | 0.5 | GPG |
| CHLORIDE        |      | % | CATION LOAD FACTOR Y     | 0.5 | GPG |
| CARBONIC ACID   | 83.  | % | SILICA                   | 0.1 | GPG |
| MONOVALENT IONS | 0.   | % | CARBON DIOXIDE           | 0.0 | GPG |
| SILICA          | 17.  | % | STRONG BASE LOAD FACT. Z | 0.6 | GPG |

JAMES A. O'MALLEY  
CHEMIST

(SEE REVERSE SIDE FOR ADDITIONAL INFORMATION)